

KLEIN



KLEIN®

**Architectural
Interior Systems**



**Presentación KLEIN/**

KLEIN Introduction 008

Conceptos arquitectónicos/

Architectural concepts 014

Accesorios/

Accessories 028

Interiorismo vidrio/

Glass Interior design 038

Interiorismo madera/

Wood Interior design 114

Diseño industrial/

Industrial design 162

Muebles y armarios/

Furniture and wardrobes 174

Architectural Interior Systems

**ACCESORIOS/
ACCESSORIES**

028

TEMPO 030

NATURE **NEW** 032KIT SWING DOOR **NEW** 034**INTERIORISMO VIDRIO/
GLASS INTERIOR DESIGN**

038

NATURE **NEW** 044

ROLLGLASS+ 048

FRONT 052

LIGNEA 056

UNIKGLASS+ 062

LITE GLASS / LITE GLASS+ 066

UNIKGLASS+ AIR 074

EXTENDO / EXTENDO CORNER 076

PANORAMIC 082

POCKET GLASS 086

ROLLGLASS 088

ROLLGLASS AUTOPORTANTE 090

ROLMATIC / ROLMATIC CORNER 094

UNIKMATIC / UNIKMATIC CORNER 096

UNIKSELF 100

UNIKAIR SELF 102

UNIKMATIC AIR 103

ROLLGLASS SELF 104

KT GLASS 106

NK GLASS 108

CLOS GLASS 109

STOCKGLASS 110

**INTERIORISMO MADERA/
WOOD INTERIOR DESIGN**

114

LITE / LITE+ 120

SLID 128

SLID FOLD 132

SLID PAR 136

SENSUS **NEW** 140

NK 144

KT 146

LITE PAR 148

LITE FOLD 150

NK FOLD 154

NK PAR 154

KP 156

STOCKPANEL 158

**DISEÑO INDUSTRIAL/
INDUSTRIAL DESIGN**

162

K 166

PL 168

AR 170

**MUEBLES Y ARMARIOS/
FURNITURES AND
WARDROBES**

174

K 178

ROLL 180

NK PAR 184

Utilice nuestra herramienta para personalizar su sistema corredero y descargue los detalles constructivos a medida para su próximo proyecto: [Configurador.klein-europe.com](https://configurator.klein-europe.com)

Visit our sliding system customization tool and download your personalized construction details for your next project: [Configurator.klein-europe.com](https://configurator.klein-europe.com)



Somos expertos en diseño y fabricación de sistemas para puertas y tabiques correderos y plegables. Nuestros valores se centran en una continua búsqueda de la excelencia, con el fin de conseguir la máxima satisfacción de nuestros clientes en términos de calidad, diseño, funcionalidad y servicio.

Damos apoyo a los profesionales de la arquitectura y de la construcción, involucrándonos en su proyecto desde su inicio, proporcionándoles aplicaciones que les ayudan a crear con total libertad conceptual espacios singulares y versátiles.

We are experts in the design and manufacturing of systems for sliding and folding partitions and doors. Our values are rooted in continuously striving for excellence, and thus ensuring that our customers are extremely satisfied with the quality, design, functionality and service that we offer.

We support professionals working in the fields of architecture and construction by being involved in their projects from the start and providing them with applications that allow them to create unique and versatile spaces with complete conceptual freedom.

90

YEARS
EXPERIENCE



NETWORK
WORLDWIDE

5

YEARS
WARRANTY







«Immer besser seit 1931»

Nuestra experiencia profesional se remonta a 1931, año de creación de nuestra empresa. Desde entonces, hemos evolucionado sin descanso, combinando nuestra vocación artesanal con los sistemas de producción más innovadores. El pequeño taller original se ha convertido en una empresa con presencia internacional, con filial en Estados Unidos.

Los valores que nos han guiado hasta aquí mantienen su plena vigencia: una incesante búsqueda de la excelencia, la apuesta por la inversión en I+D+i y una escucha activa de los profesionales de la arquitectura y la construcción cimientan el éxito global de la marca KLEIN y siguen marcando nuestro rumbo al futuro.

Our professional experience dates back to 1931, the year that our company was founded. Since then, we have continued to evolve, combining our artisanal craft with the most innovative production systems. The small workshop where we started has grown into an international company, with a subsidiary in the United States.

The values that have guided us to where we are today are still as present as ever: our relentless pursuit of excellence, commitment to investing in research, development and innovation, and active incorporation of ideas from professionals in the architecture and construction fields have laid the foundation for KLEIN's global success and continue to lead us on our path forward.



NATURE | Interiorismo Vidrio - Glass Interior Design



Nuestro departamento de I+D+i es el centro de nuestro proceso de diseño y creación de nuevos productos, guardián de la altísima exigencia de la marca. En nuestras instalaciones de Barcelona llevamos a cabo todas las fases de diseño, modelización 3D, prototipado y ensayos, así como la fabricación de todos nuestros productos.

Nuestros sistemas son producidos a partir de aluminio de origen europeo únicamente. Superan la norma EN1527 mediante un test a más de 100.000 ciclos y ofrecen una garantía de 5 años.

Nos enorgullece el reconocimiento internacional de nuestros clientes y proveedores así como el aval recibido de los principales organismos de certificación internacionales y entidades de diseño.

Estamos activamente comprometidos en proteger el medio ambiente y llevamos a cabo una política de reducción constante de nuestro impacto. Mejoramos día a día nuestros procesos con el fin de diseñar y fabricar productos que tengan un impacto positivo en las personas y el planeta y los validamos con el aval de los sellos medioambientales más exigentes.

Our R+D+i department is at the core of our new product design and creation process, guardians of the brand's extremely high standards. We carry out all phases of design, 3D modeling, prototyping and testing at our facilities in Barcelona, as well as the manufacturing of all our products.

Our systems are exclusively produced with European-made aluminum. After being tested to over 100,000 cycles, all of our systems exceed the EN 1527 standard and come with a 5-year warranty.

We are proud of our customers and suppliers' international recognition, as well as the backing we have received from leading international certification organizations and design entities.

We are actively committed to protecting the environment, while also pursuing a policy of constantly reducing our impact. We are consistently improving our processes in order to design and manufacture products that have a positive impact on people and the planet and we validate them with the most demanding environmental certifications.



reddot winner 2021



Sistema de Gestión
ISO 9001:2015
ISO 14001:2015
www.luxu.com
ID: 9105617540



Arquitectura sostenible y del bienestar

Green and Wellness Architecture



Los arquitectos, diseñadores y constructores están concibiendo interiores singulares y sostenibles que encajan a la perfección con un futuro centrado en el bienestar. Los materiales utilizados importan, y tanto el vidrio como la madera desempeñan un papel esencial.

KLEIN ha comprendido que el diseño no solo marca la diferencia, sino que debe ir un paso por delante y permitir implementar nuevas estrategias. Por eso la marca pone el foco en la innovación sostenible.

Leer más en:
www.klein-europe.com/es/noticias

Architects, designers and builders are creating distinctive and sustainable interiors. The materials used matter, and both glass and wood play an essential role.

KLEIN has understood that design not only makes a difference, but must be one step ahead in order to help implementing new strategies. That's why the brand focuses on sustainable innovation.

More info on:
www.klein-europe.com/en/news



LITE+ | Roman Izquierdo Bouldstridge



SLID | LOCA Estudio



Comfort

Comfort



SLIDING DOOR SYSTEMS

Usamos la luz natural, fuente de vida y de alegría, como elemento creativo. La convertimos en herramienta arquitectónica transformadora de espacios llenos de fuerza y modernidad.

We use natural light, a source of life and joy, as a creative element, turning it into a transformative architectural tool capable of creating spaces full of strength and modernity.

KLEIN®

Pro porción

Balance



Nuestros sistemas hacen realidad el concepto de fluidez espacial: son elementos de conexión, de equilibrio y armonía visual.

Our systems make the concept of spatial fluidity a reality: they are rooted in elements of connection, balance and visual harmony.



A photograph of a modern interior hallway. The ceiling is white with a textured, cracked finish. The walls are made of light-colored wood panels. A sliding door system is visible, with a door partially open, revealing a bathroom with a toilet. To the right, a red pendant light hangs from the ceiling. The floor is made of reddish-brown square tiles.

Muta bilidad

Flexibility

Generamos espacios dinámicos, capaces de transformarse mediante un movimiento orgánico que respeta los ritmos del habitar.

We generate dynamic spaces, capable of being transformed through organic movement that respects the rhythms of life.



Innovación con sentido

Innovate with meaning

Orgánica, ligera y cálida. Emocionalmente relajada. Visualmente protagonista. Y naturalmente sostenible.

Presentamos NATURE, el primer sistema estándar de guía de madera de roble eco-friendly que estructura paneles de vidrio fijos y correderos.

Galardonado con el prestigioso Red Dot Award 2021, en su categoría Product Design, Nature es el fruto que nace cuando la innovación más pura se nutre de maestría artesana para crear un producto único, diferencial, sensual y emotivo.

Con Nature pretendemos influir significativamente en la creación de espacios más cálidos, confortables y, sobre todo, más sanos.

Más en www.klein.es/nature

Organic, lightweight, and warm. Emotionally relaxed. Visually captivating. And naturally sustainable.

Presenting NATURE, the first standardized sliding system assembled with a light, eco-friendly oak wood track that joins fixed and sliding glass panels.

Winner of the prestigious Red Dot Award 2021, in the Product Design category, Nature is the result when the purest innovation draws upon masterful artisanship to create a unique, distinctive, sensual, and moving product.

With Nature, we want to have a significant impact on the creation of warmer, more comfortable, and, above all, healthier spaces.

More about in <https://www.klein-europe.com/nature>



reddot winner 2021



Nueva versión T de nuestros sistemas Lite+ y Lite Glass+

Porque algunos proyectos requieren el minimalismo más absoluto y la total ausencia de aluminio, hemos desarrollado la nueva versión T, empotrada e invisible, de nuestros sistemas LITE+ para madera y LITE Glass+ para cristal. Con ellas aportamos una respuesta técnica y estéticamente bella para todos los profesionales involucrados en el diseño y la ejecución del proyecto.

Una vez instalada, solo se percibe una fina línea de sombra en el techo.

¡Sabemos que lo estabais esperando!

New T version of our Lite+ and Lite Glass+ systems

Because some projects require the most absolute minimalism and the total absence of aluminium, we have developed the new T version, recessed and invisible, of our LITE+ systems for wood and LITE Glass+ for glass. With them we provide a technically and aesthetically beautiful answer for all professionals involved in the design and execution of the project.

Once installed, only a thin line of shadow is visible on the ceiling.

We know you've been waiting for it!

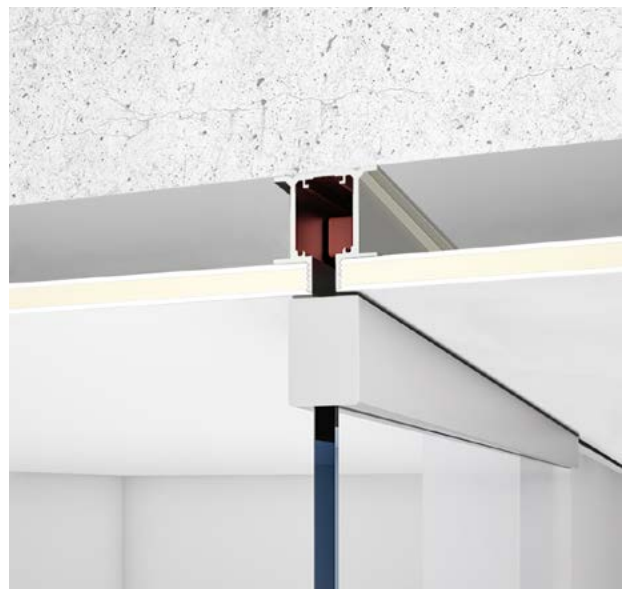

Casi un siglo de historia nos ha proporcionado un profundo conocimiento fruto de la experiencia de las generaciones pasadas y el entusiasmo de las presentes.

Un conocimiento en constante crecimiento y que, sin duda, es clave en el proceso de innovación.

Mundo SLID

Presentamos la clásica guía SLID, ahora con el sistema de frenado KSC, KLEIN Soft Closing integrado, para una mayor sensación de levedad y confort.

Además, ampliamos los horizontes multiplicando las aplicaciones de SLID. Lanzamos también sus versiones plegables:

SLID PAR. De 2 paneles o 2+2 paneles plegables, sin guía en el suelo.

SLID FOLD. De hasta 5 paneles plegables, con guía inferior.

En ambos disponible en plegado central y lateral, con opción vista o empotrada.

Instalaciones de hasta 150 kg absolutamente personalizables al servicio del usuario.

Almost a century of history has provided us with profound knowledge, a culmination of mixing the experience of past generations and the enthusiasm of present ones.

A constantly growing knowledge that is, without a doubt, key to the innovation process.

The SLID World

Introducing the classic SLID guide, now with the KSC, KLEIN Soft Closing system integrated, for an even greater for a feeling of lightness and comfort.

In addition, we broaden the horizons by multiplying SLID's applications. We are also launching its folding versions:

SLID PAR. 2 panels or 2+2 folding panels, without floor tracks.

SLID FOLD. 5 folding panels, with a bottom track.

In both cases Central or Side folding, in retrac applications with recessed or exposed installation.

Installations up to 150 kg fully customizable to the service of the user.

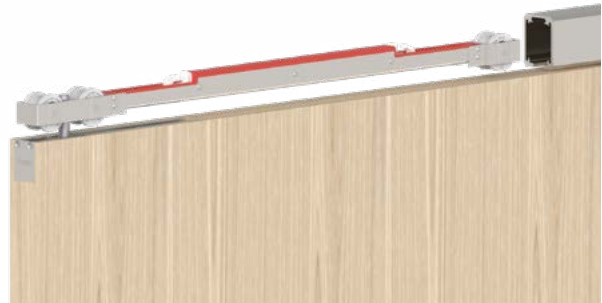



Rollglass+

Ampliamos la gama Rollglass+ hasta 250 kg, con KSC - KLEIN Soft Closing incorporado.

Un único perfil de puro aluminio, compacto, incluso invisible en caso de aplicación empotrada a falso techo, deja todo el protagonismo al espacio proyectado.

Ideal para proyectos que requieren paneles de gran formato y exigencia estética.

We are extending the Rollglass+ range up to 250 kg, with KSC - KLEIN Soft Closing

A single, compact, pure aluminum profile, which can even be made invisible when installed as a recessed drop ceiling application, puts the spotlight on the projected space.

Ideal for projects requiring large format panels and aesthetically demanding.

KLEIN a tu servicio

KLEIN at your service

**CONFIGURADOR:
Ampliamos las funciones de la
herramienta de KLEIN®**

Especialmente diseñado para facilitar el día a día de los Arquitectos e Instaladores, el configurador KLEIN ahora permite personalizar de manera intuitiva los detalles constructivos de los sistemas correderos de cristal, de madera y plegables, de acuerdo con tu proyecto.

¡Nunca ha sido tan fácil obtener unos dibujos técnicos personalizados!

Configurador.klein-europe.com

**CONFIGURATOR:
A new tool by KLEIN®**

Specially designed to make life easier for Architects and Installers, the KLEIN configurator allows you to intuitively customize the construction details of sliding glass, wood and folding door systems, as required by your project.

It's never been easier to find customized technical drawings!

Configurator.klein-europe.com



Configurador KLEIN® | Herramienta de diseño - Design tool

NUEVA TIENDA ONLINE PARA PROFESIONALES DE LA CONSTRUCCIÓN:

Nueva forma más eficiente, cómoda y fácil de comprar nuestros productos.

Con la nueva tienda online de KLEIN, recibe el sistema completo en un único paquete que integra perfiles y juego de accesorios.

Nuestro asistente de compra guiada estará disponible para ti 24 horas, los 7 días de la semana.

<https://tienda.klein-europe.com>

NEW ONLINE SHOP FOR CONSTRUCTION PROFESSIONALS:

New, more efficient, convenient and easier way to buy our products.

Receive the complete system in a single package including profiles and accessories with the new KLEIN online shop.

Our guided shopping assistant will be available to you 24 hours a day, 7 days a week.

Available in Spain and soon in the rest of Europe.

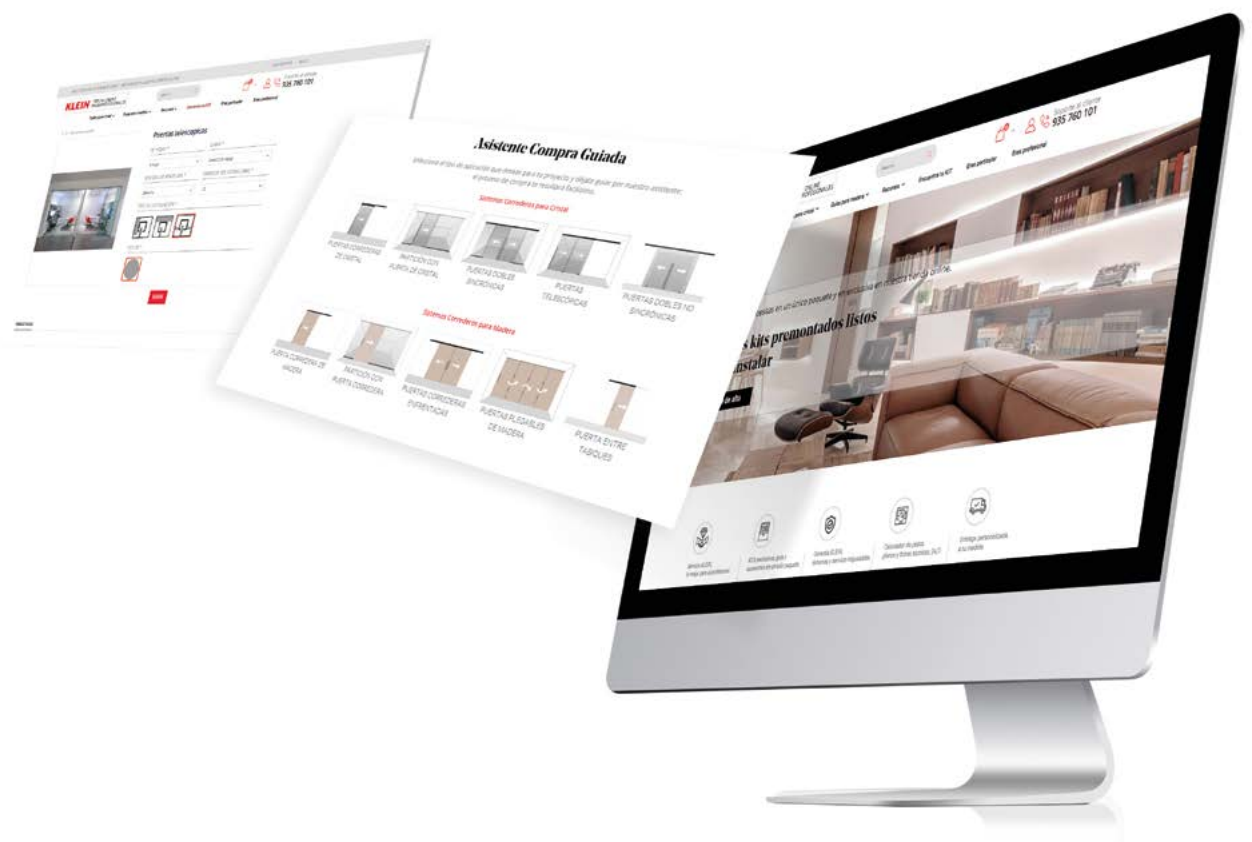





ACCESORIOS

Accessories



Tempo

Tempo es un elegante tirador con una pequeña curva en su parte central que otorga confort y suavidad. Una precisa ergonomía para que se necesite solo unos dedos para mover una puerta suavemente, al ritmo de su usuario.

El juego de tiradores está disponible para ser atornillado o pegado.

Tempo is an elegant handle with a small curve in its central part that provides comfort and softness. A precise ergonomics so that only a few fingers are needed to move a door smoothly, to the rhythm of its user.

The handle set is available to be screwed or glued.

- Alu. Silver Mate
Alu. Silver Matte
- Alu. Negro Mate
Alu. Black Matte
- Alu. Bronce Mate
Alu. Bronze Matte

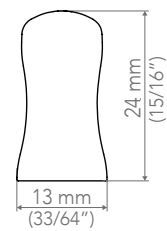



SECCIÓN ATORNILLADO / SCREWED

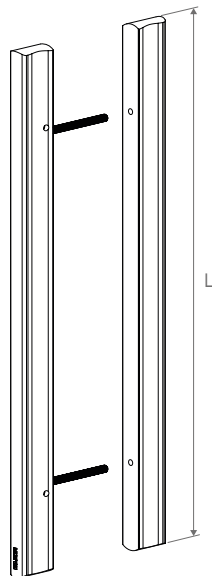

L = 300 mm (12")
L = 700 mm (28")

SECCIÓN ADHESIVO / GLUED

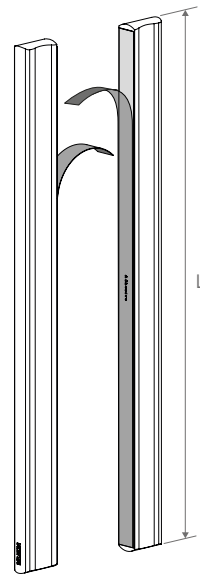

L = 300 mm (12")
L = 700 mm (28")



Nature

El tirador Nature es un manillon de roble con personalidad natural.

Aporta calidez a las puertas correderas de madera y cristal con un diseño contenido y lleno de detalles que transmite un perfecto equilibrio entre la función, la sensualidad y la emoción.

Tallado en madera de roble certificada PEFC, para acreditar el empleo de maderas sostenibles de la mejor calidad y un acabado manual con baño de aceite y ceras naturales. Todo ello para realzar la materialidad de un diseño de líneas suaves que seduce con su cálido tacto.

The Nature handle is an oak pull handle with a natural feel.

It gives sliding wood and glass doors a touch of warmth, with a restrained design full of details that provide the perfect balance between function, sensuality, and emotion.

Carved out of PEFC-certified oak wood, to demonstrate the use of sustainable woods of the highest quality, manually treated with natural oil and wax. These components all come together to highlight the materiality of a design made up of smooth lines that seduce with their warm character.

- Natural
Natural
- Barnizado ECO
ECO-Varnished

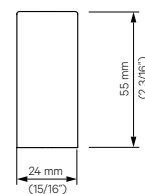



PARA VIDRIO / FOR GLASS

PARA MADERA/ FOR WOOD

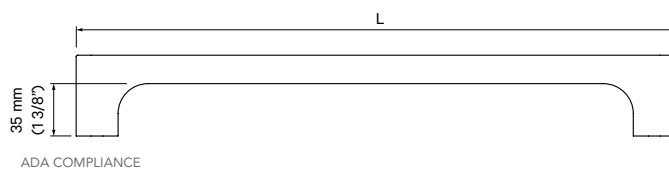
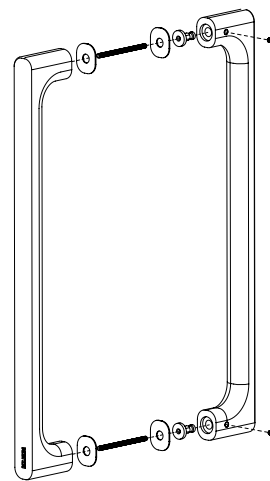
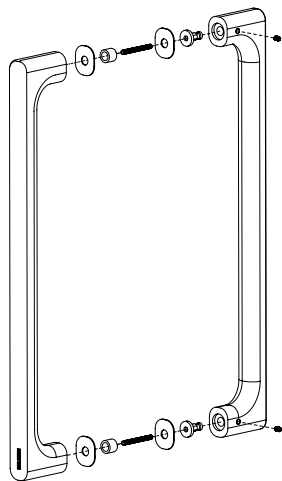

L = 400 mm (15 3/4'')



Kit Swing Door

Kit de puerta batiente que complementa las particiones de cristal EXTENDO, ROLLGLASS+ y PANORAMIC. Diseño minimalista con las bisagras y mordazas ocultas.

Kit for swing doors that complements the EXTENDO, ROLLGLASS+ and PANORAMIC glass partitions. Minimalist design with concealed hinges and clamps.

- Alu. Silver Mate
Alu. Silver Matte
- Alu. Negro Mate
Alu. Black Matte

Peso: 100 kg
Weight: 220 lbs

Freno/
Brake: SELF

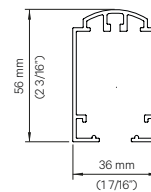



PARA PANORAMIC / FOR PANORAMIC

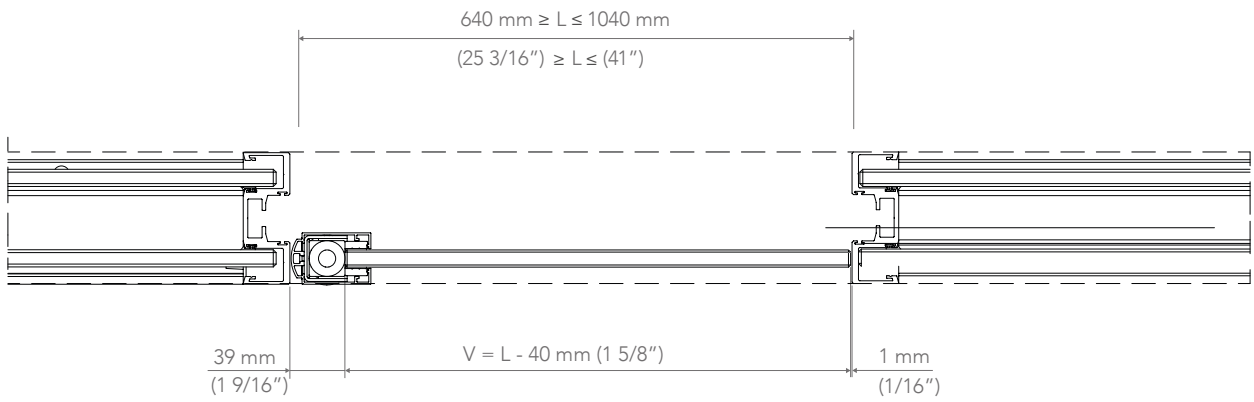

PARA ROLLGLASS+ / FOR ROLLGLASS+

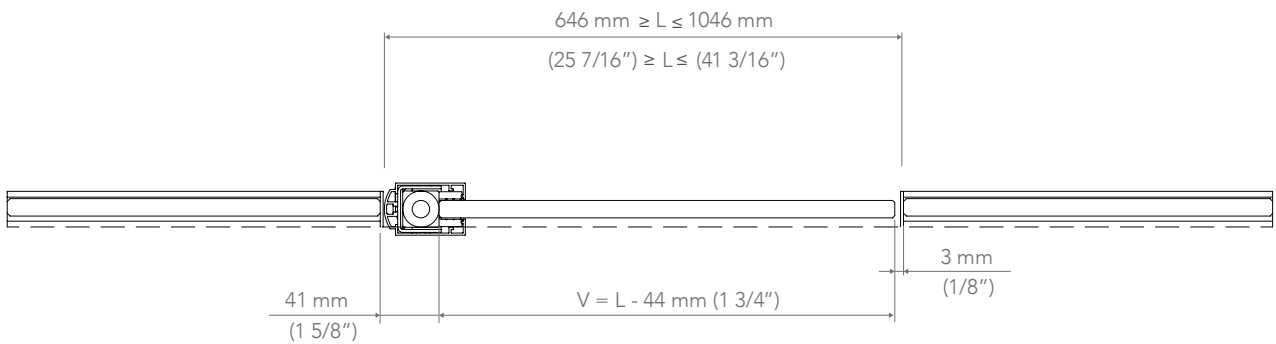

PARA EXTENDO / FOR EXTENDO

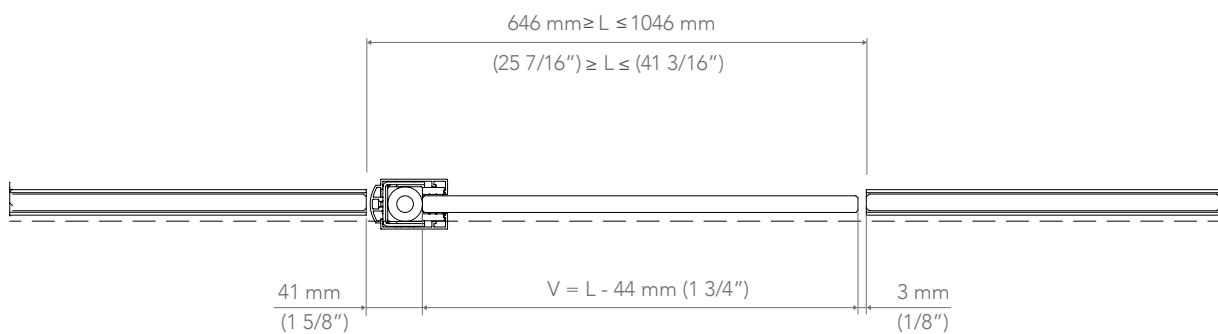



INTERIORISMO
VIDRIO

Glass Interior Design





Vidrio: Transparencia y libertad

Glass: Transparency and freedom

ESPACIOS SIN FRONTERAS

Libertad para conectar, abrir o crear espacios, sin barreras. Aunque el cristal es pura transparencia, se convierte en protagonista de la arquitectura. Potencia la luz natural y juega con las sombras. Nuestros sistemas permiten poner en escena su espectacular belleza con absoluta sencillez. Sin marcos. Sin guías en el suelo. Menos es más.

SPACES WITHOUT BORDERS

Freedom to connect, open up or create spaces, without barriers. Although glass is pure transparency, it becomes the protagonist of the architecture, boosting natural light and playing with shadows. Our systems allow its spectacular beauty to be put on display with absolute simplicity. Without frames. Without floor tracks. Less is more.







La nueva mordaza KLEIN+ sujeta el cristal mediante presión para evitar marcos y procesos de mecanizado. Sin guías en el suelo, el vidrio laminado o templado parece flotar y se desliza suavemente, cualquiera que sea su formato.



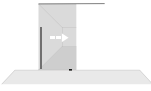
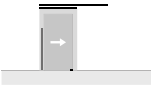
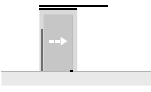

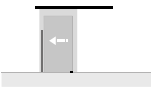
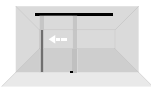

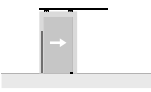
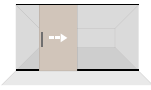
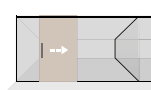
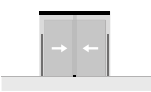
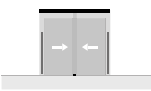
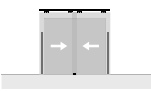



The new KLEIN+ clamp fastens the glass with pressure, doing away with the need for frames and drilling. Without any floor tracks, the laminated or tempered glass seems to float, sliding along smoothly, regardless of its size.

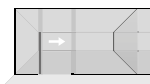

UNIKGLASS+ | Interiorismo Vidrio - Glass Interior Design

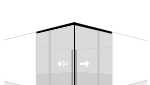
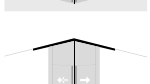
APLICACIÓN/ APPLICATION	PRODUCTO/ PRODUCT	PÁG./ PAGE	PESO*/ WEIGHT*		FRENO BRAKE			INSTALACIÓN MOUNTING		
			≤100	>100	KBS	KSC	SELF	PARED WALL	TECHO CEILING	EMPOTRABLE RECESSED
PUERTAS CORREDERAS ÚNICAS/ SINGLE SLIDING DOORS		UNIKGLASS+	062	●		●	●	●	●	●
		LITE GLASS	066	●				●	●	●
		LITE GLASS +	066	●			●	●	●	●
		UNIKGLASS+ AIR	074	●		●	●	●		
		POCKET GLASS	086	●	●			●	●	●
		UNIKSELF	100	●				●		
		UNIKAIR SELF	102	●				●		
		KT GLASS	106	●	●			●	●	
		NK GLASS	108	●				●	●	
FRENTE ACRISTALADO + PUERTA CORREDERA DE MADERA/ GLAZING FIXED + SLIDING WOODEN DOOR		FRONT	052	●			●		●	●
		LIGNEA	056	●			●		●	
PUERTAS PARALELAS/ BI PASSING DOORS		LITE GLASS	066	●				●	●	●
		LITE GLASS +	066	●			●	●	●	●
		CLOS GLASS	109	●					●	

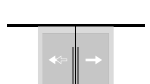
Personaliza nuestras aplicaciones en [Configurador.klein-europe.com](https://configurador.klein-europe.com)
 Customize our applications on [Configurador.klein-europe.com](https://configurador.klein-europe.com)

APLICACIÓN/ APPLICATION	PRODUCTO/ PRODUCT	PÁG./ PAGE	PESO*/ WEIGHT*		FRENO BRAKE			INSTALACIÓN MOUNTING		
			≤100	>100	KBS	KSC	SELF	PARED WALL	TECHO CEILING	EMPOTRABLE RECESSED
PUERTAS TELESCÓPICAS/ TELESCOPIC DOORS		EXTENDO	076	●	●			●	●	●
FRENTE ACRISTALADO + PUERTA CORREDERA/ GLAZING FIXED + SLIDING GLASS DOOR		NATURE	044	●			●		●	
		ROLLGLASS+	048	●	●	●	●		●	●
		PANORAMIC	082	●	●				●	●
		ROLLGLASS	088	●					●	
		ROLLGLASS AUTOPORTANTE	090	●				●		
		ROLLGLASS SELF	104	●					●	
PUERTAS EN ESQUINA/ CORNER DOORS		EXTENDO CORNER	076	●	●			●	●	●
		ROLMATIC CORNER	094	●					●	
		UNIKMATIC CORNER	096	●				●		
PUERTAS ENFRENTADAS/ BI PARTING DOORS		ROLMATIC	094	●					●	
		UNIKMATIC	096	●				●		
		UNIKMATIC AIR	103	●				●		
PUERTAS APILABLES/ STACKABLE DOORS		STOCKGLASS	110	●	●				●	

* Su peso se calcula en base a la siguiente fórmula: Altura [m] x Ancho [m] x Espesor [mm] x 2,5 = Peso [kg]

* The weight is calculated based on the following formula: Height [m] x Width [m] x Thickness [mm] x 2,5 = Weight [kg]



Nature

Nature es el primer sistema corredero que se articula mediante una guía de madera de roble eco-friendly.

De madera de roble certificada PEFC, para acreditar el empleo de maderas sostenibles de la mejor calidad y un acabado manual con baño de aceite y ceras naturales.

Versátil y flexible, permite múltiples combinaciones y cuida todos los detalles.

Nature es orgánica, ligera y cálida. Emocionalmente relajada. Visualmente protagonista. Y naturalmente sostenible.

Nature is the first sliding system that is articulated by means of an eco-friendly oak wood guide.

Carved out of PEFC-certified oak wood, to demonstrate the use of sustainable woods of the highest quality, manually treated with natural oil and wax.

Versatile and flexible, it allows multiple combinations and takes care of every detail.

Nature is organic, lightweight, and warm. Emotionally relaxed. Visually captivating. And naturally sustainable.

- Natural**
Natural
- Barnizado ECO**
ECO-Varnished

Peso:	100 kg
Weight:	220 lbs
Freno/ Brake:	KSC

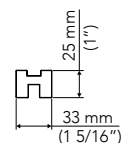
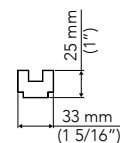
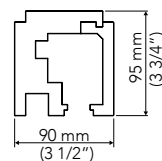

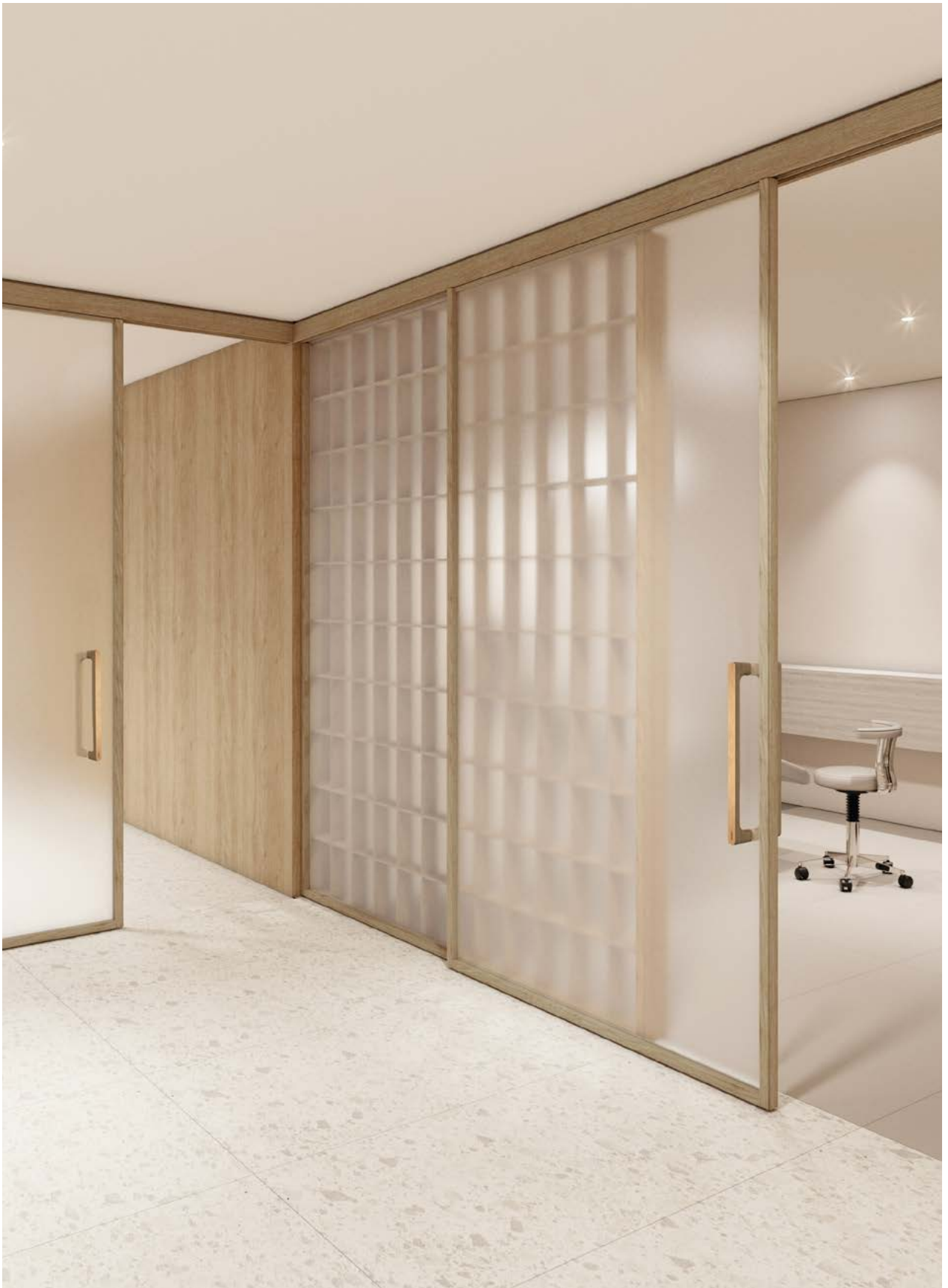

***PUERTA SIN MARCO/
DOOR FRAMELESS**

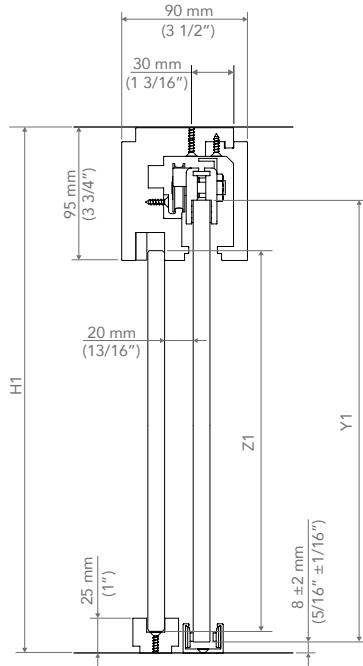

Z1 = H1 - 103 mm (4 1/16")
Y1 = H1 - 60 mm (2 3/8")

****PUERTA CON MARCO/
DOOR FRAMED**

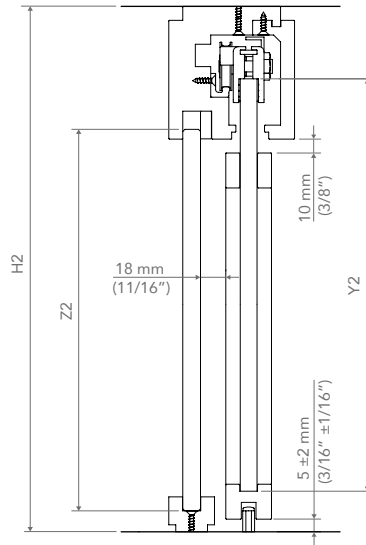

Z2 = H2 - 103 mm (4 1/16")
Y2 = H2 - 77 mm (2 1/1")

****PUERTA Y FIJOS CON MARCO/
DOOR AND FIXED WITH FRAME**

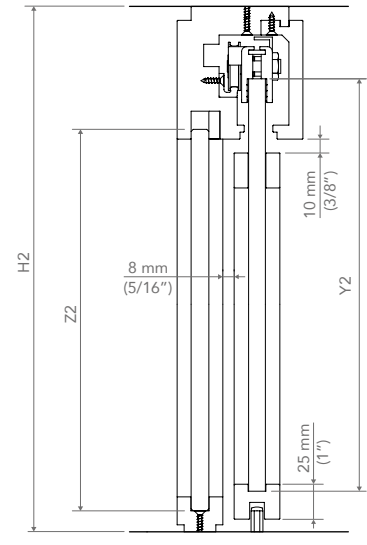

Z2 = H2 - 103 mm (4 1/16")
Y2 = H2 - 77 mm (2 1/1")

H Max.

* H max. = 3,00m

** $\begin{cases} \text{Kits 2,00m / 2,80} \longrightarrow \text{H max.} = 2,90\text{m} \\ \text{Kits 3,40m / 4,00} \longrightarrow \text{H max.} = 3,00\text{m} \end{cases}$









Rollglass+

Rollglass+ crea un frente acristalado que combina paneles de vidrio fijos y móviles mediante una única guía. Puede esconderse en falso techo para un efecto absolutamente minimalista, con un perfil premarco que posibilita una instalación por fases. Versátil y flexible, permite variadas combinaciones y cuida todos los detalles.

Disponibles con o sin perfil inferior para el vidrio fijo. Regulable en altura para facilitar la instalación.

Sistema de frenado de la puerta disponibles:
KSC - Klein Soft Closing, detención suave controlada.

KBS - Klein Brake System, tope con freno amortiguador. Disponible para Rollglass+ 50/100.

-  Alu. Silver Matte
Alu. Silver Matte
-  Alu. Negro Matte
Alu. Black Matte
-  Alu. Bronce Matte
Alu. Bronze Matte

Rollglass+ creates a glass front that combines fixed and mobile glass panels on a single track. It can be hidden in a drop ceiling for a completely minimalist effect, with a recessed frame track that allows for a phased installation. Versatile and flexible, it allows for various combinations, and is precise down to the smallest detail.

Available with or without a bottom profile for the fixed glass.

Door braking systems available:

KSC - Klein Soft Closing, smooth, controlled closing.

KBS - Klein Brake System, stop with damper brake available for Rollglass+ 50/100.

Peso máx./	250 kg
Max. weight:	550 lbs

Freno/ Brake:	KSC KBS
------------------	------------

ROLLGLASS+ 250

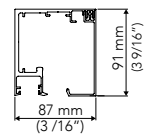

ROLLGLASS+ 150

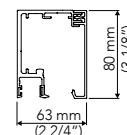

ROLLGLASS+ 150 TOP

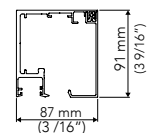

ROLLGLASS+ 50/100

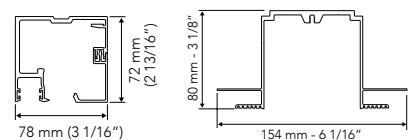



VISTO / EXPOSED

ROLLGLASS+ 50/100

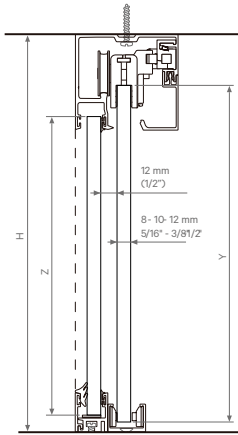

$Y1 = H1 - 47 \text{ mm (1 13/16")}$

$Z1 = H1 - 74 \text{ mm (2 7/8")}$

ROLLGLASS+ 150

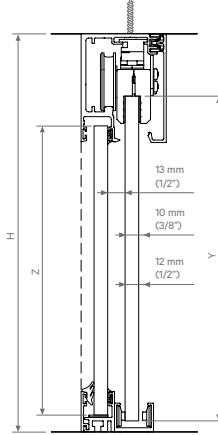

$Z = H - 79 \text{ mm (3 1/8")}$

$Y1 = H - 74 \text{ mm (2 1/8")}$

ROLLGLASS+ 250

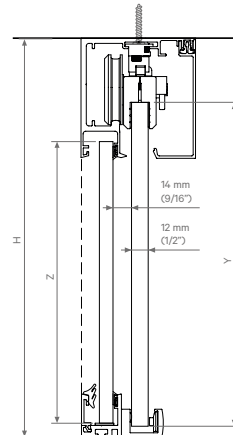

$Z1 = H1 - 89 \text{ mm (3 1/2")}$

$Y1 = H1 - 57 \text{ mm (2 1/4")}$

EMPOTRADO / RECESSED

ROLLGLASS+ 50/100

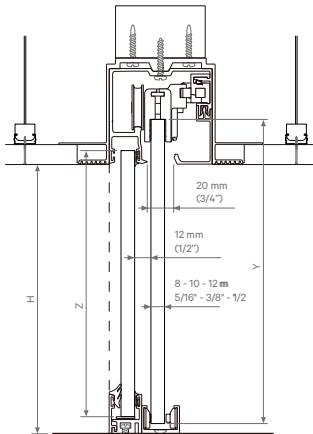

$Z = H$

$Y = H + 26 \text{ mm (1")}$

ROLLGLASS+ 150 TOP

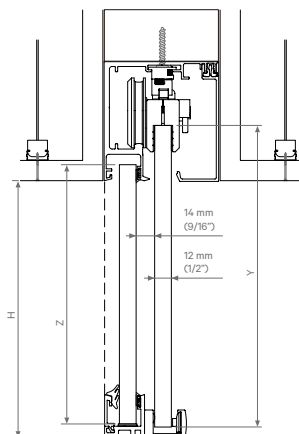

$Z = H$

$Y = H + 34 \text{ mm (1 11/32")}$

ROLLGLASS+ 250

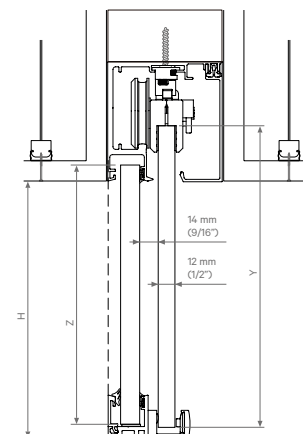

$Z = H$

$Y = H + 34 \text{ mm (1 11/32")}$

(VIDRIO FIJO / FIXED GLASS)

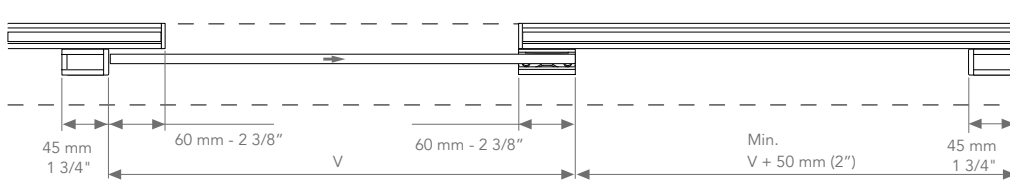

(VIDRIO FIJO / FIXED GLASS)

ROLLGLAS+ 50/100 KSC: $V \geq 800 \text{ mm (31 1/2")}$
 ROLLGLAS+ 150 KSC: $V \geq 1.100 \text{ mm (43")}$
 ROLLGLAS+ 250 KSC: $V \geq 1.500 \text{ mm (60")}$

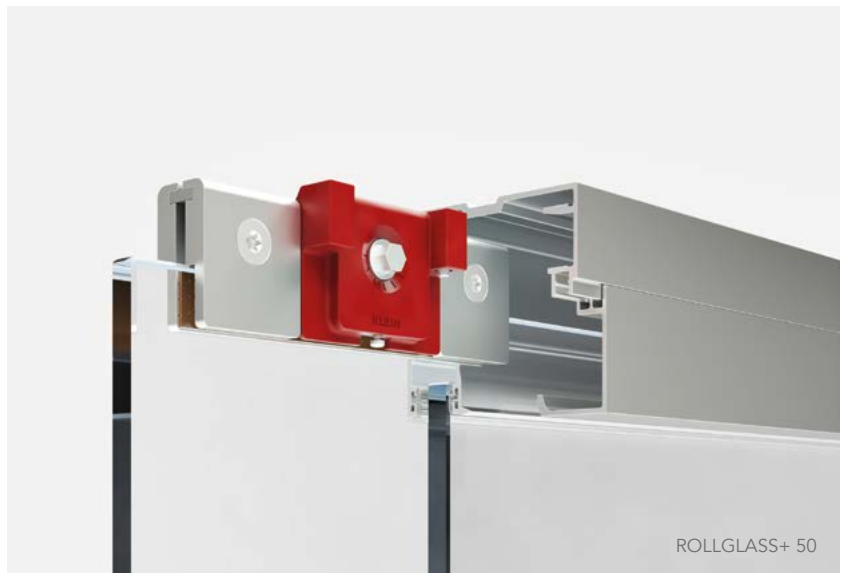
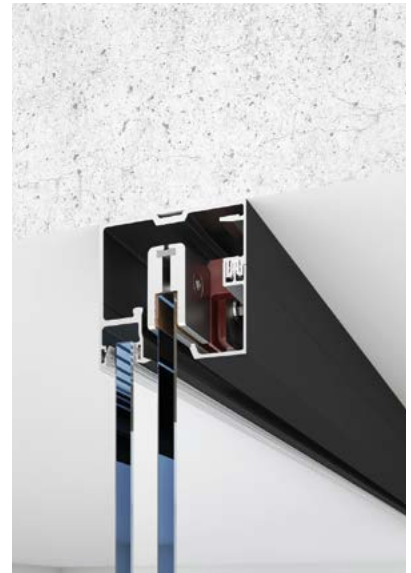
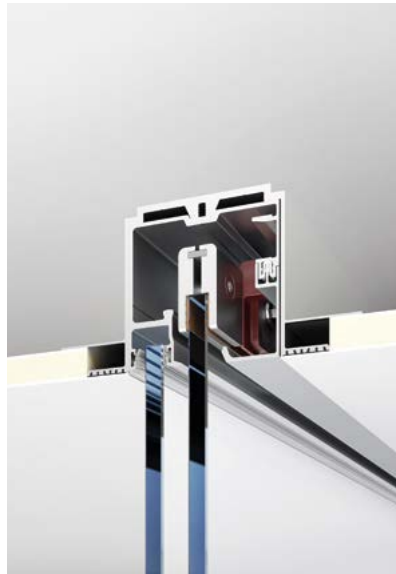

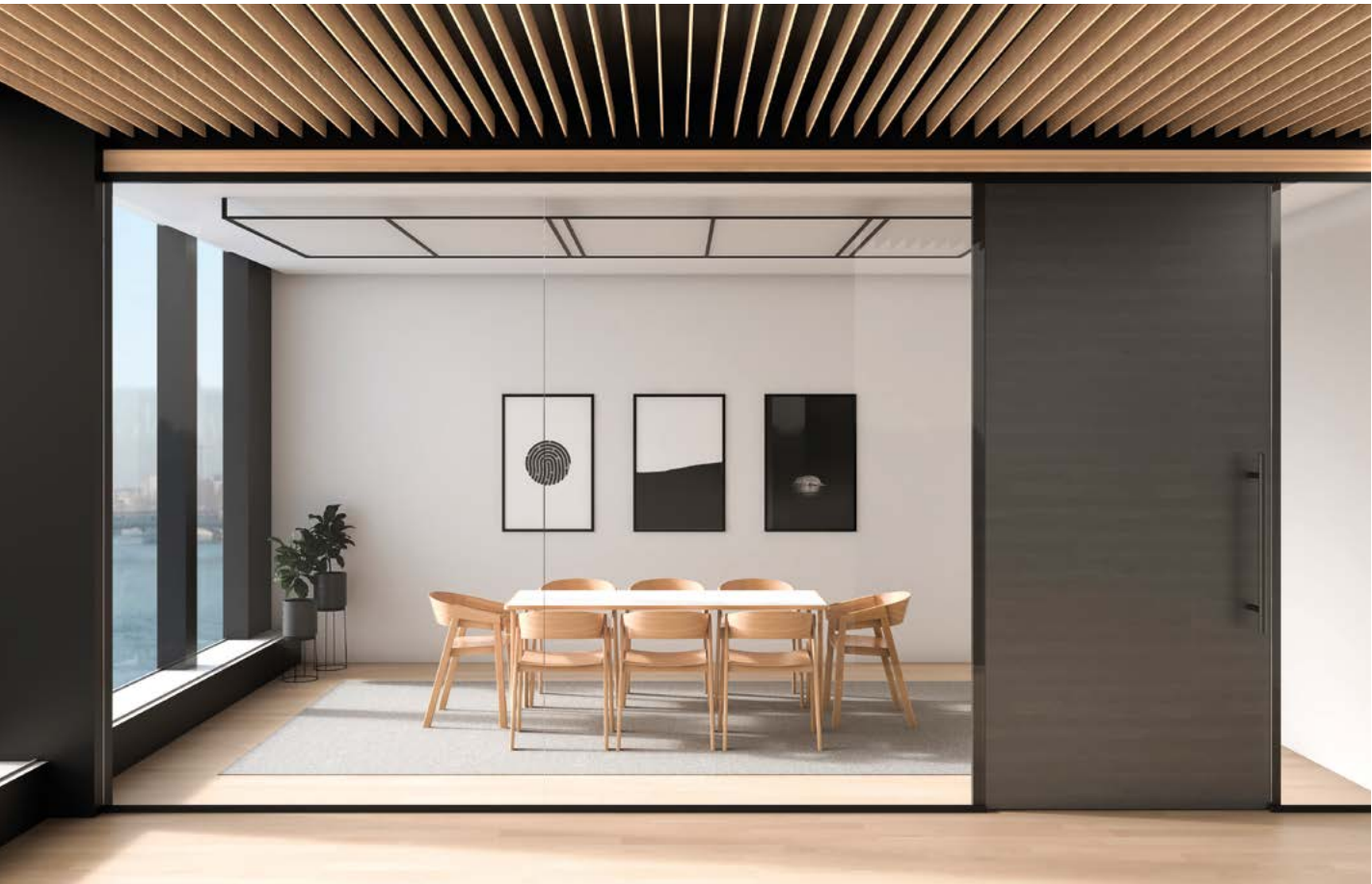

Front

Front estructura los espacios mediante un frente acristalado continuo y elegantes puertas de madera. La belleza del armónico contraste de dos materiales únicos.

Admite cristal fijo de 10 mm y de 12 mm. Puede esconderse en falso techo para potenciar la levedad del conjunto, con un perfil premarco que posibilita una instalación por fases.

Sistema de frenado **KSC** - Klein Soft Closing, detención suave controlada.

Front structures spaces with a continuous glass front and elegant wood doors. The beauty of the harmonious contrast between two unique materials.

Supports fixed glass measuring 10 mm and 12 mm. It can be hidden in a drop ceiling to accentuate the light nature of the structure, with a recessed frame track that allows for a phased installation.

KSC - Klein Soft Closing braking system, smooth, controlled closing.

- Alu. Silver Mate
Alu. Silver Matte
- Alu. Negro Mate
Alu. Black Matte
- Alu. Bronce Mate
Alu. Bronze Matte

Peso máx./ Max. weight:	100 kg 220 lbs
Freno/ Brake:	KSC

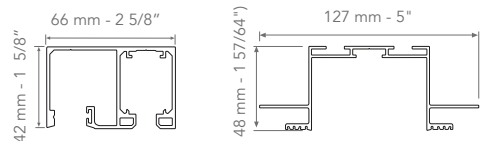



VISTO / EXPOSED

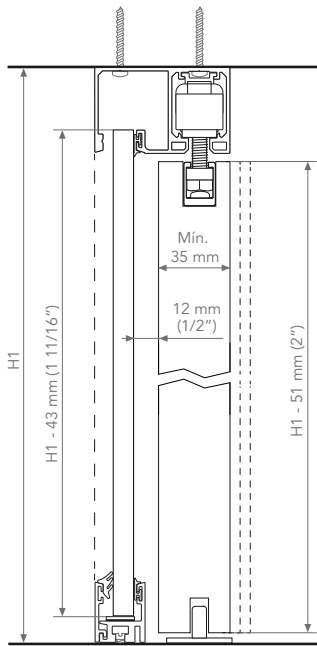

EMPOTRADO / RECESSED

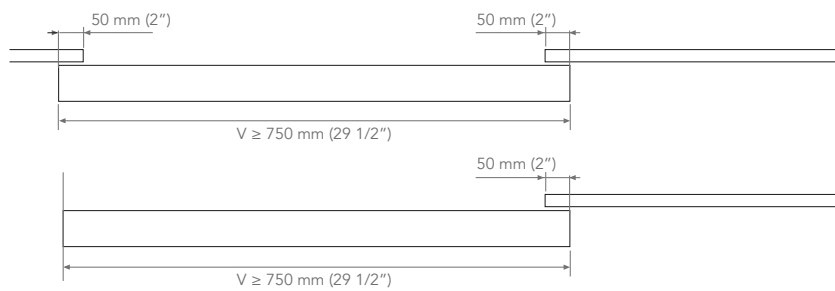
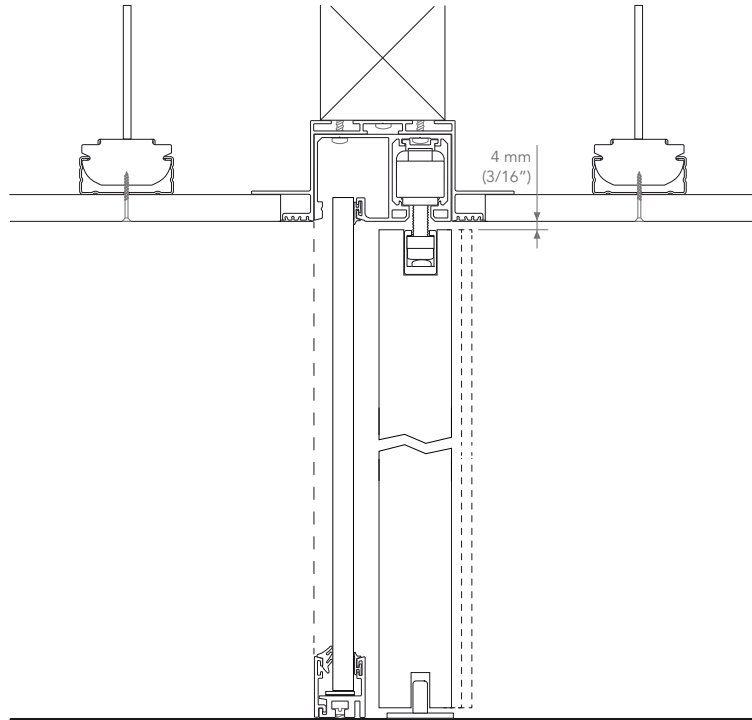

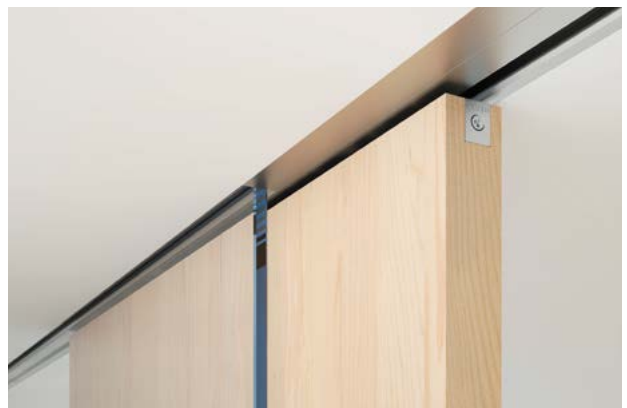



Lignea

Lignea genera espacios acristalados mediante una combinación de vidrios fijos con puertas correderas de madera y retornos en L o T para cerramientos completos.

Admite cristal fijo de 12 mm y 16 mm. Todos los detalles cuentan cuando se busca la perfección y la personalización.

Los perfiles verticales y las uniones en T y L están diseñados para facilitar el montaje y resolver con calidad los acabados de los espacios generados.

Sistema de frenado **KSC** - Klein Soft Closing, detención suave controlada.

Lignea creates glass spaces through a combination of fixed glass panels and sliding wood doors, as well as L or T closings, for completely enclosed spaces.

Supports fixed glass measuring 12 mm and 16 mm. Every last detail counts when striving for perfection and customization.

Our vertical profiles and T- and L-connectors are designed to facilitate the assembly process and create quality finishes for the spaces generated.

KSC - Klein Soft Closing braking system, smooth, controlled closing.

- Alu. Silver Mate
Alu. Silver Matte
- Alu. Negro Mate
Alu. Black Matte
- Alu. Bronce Mate
Alu. Bronze Matte

Peso máx./ Max. weight:	100 kg 220 lbs
Freno/ Brake:	KSC

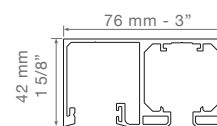



VISTO / EXPOSED

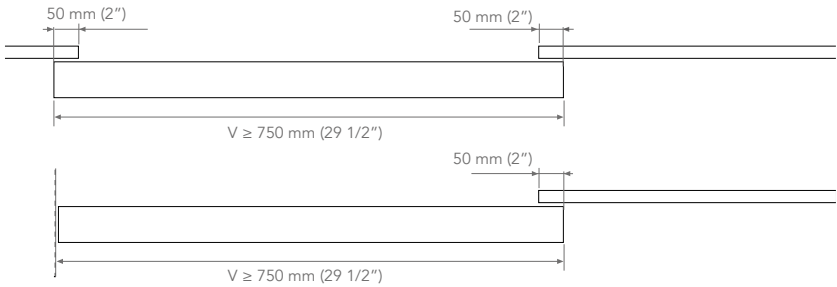
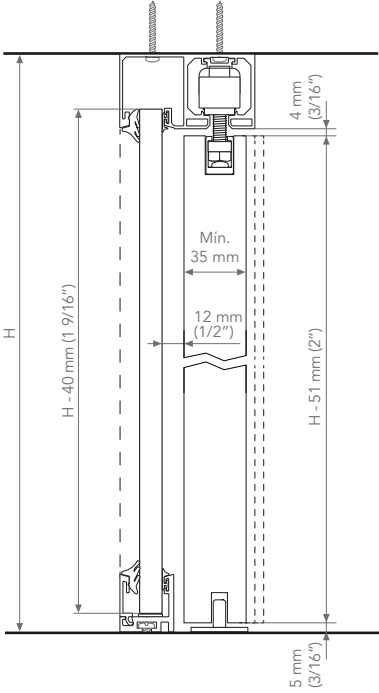



NATURE | De la Mata Arquitectura







Unikglass+

Unikglass+ conecta estancias mediante un único panel corredero de cristal. Sobrio y discreto, ahorra espacio y suma modernidad. Puede esconderse en falso techo para un efecto absolutamente minimalista, con un perfil pre-marco que posibilita una instalación por fases. La belleza de la sencillez.

Regulable en altura para facilitar la instalación.

Sistema de frenado de la puerta disponibles:

KSC - Klein Soft Closing, detención suave controlada.

KBS - Klein Brake System, tope con freno amortiguador.

Unikglass+ connects rooms with a single sliding glass panel. Restrained and discreet, it saves space and adds modernity. It can be hidden in a drop ceiling for a completely minimalist effect, with a recessed frame track profile that allows for a phased installation. The beauty of simplicity.

Easy installation.

Door braking systems available:

KSC - Klein Soft Closing, smooth, controlled closing.

KBS - Klein Brake System, stop with damper brake.

- Alu. Silver Mate
Alu. Silver Matte
- Alu. Negro Mate
Alu. Black Matte
- Alu. Bronce Mate
Alu. Bronze Matte

Peso máx./ Max. weight:	100 kg 220 lbs
Freno/ Brake:	KSC KBS

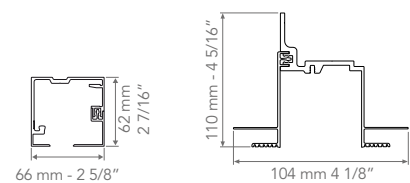



VISTO / EXPOSED

UNIKGLASS+ 50/100

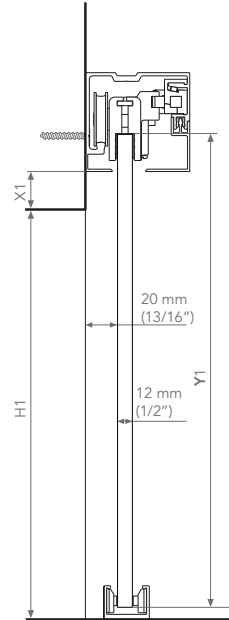

$$Y1 = H1 + X1 + 16 \text{ mm (5/8")}$$

EMPOTRADO / RECESSED

CON DINTEL / WITH LINTEL

SIN DINTEL / WITHOUT LINTEL

SIN DINTEL / WITHOUT LINTEL

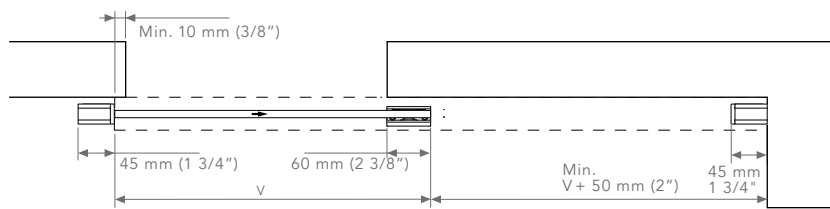
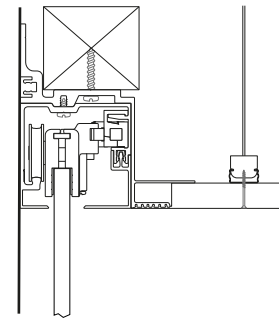
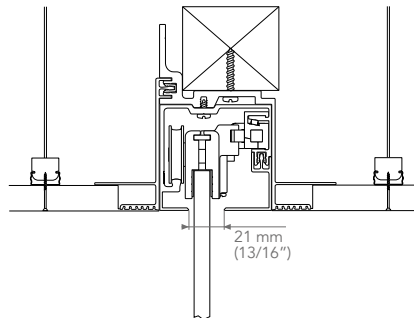
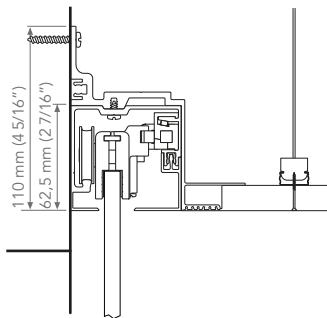

UNIKGLASS+ 50/100 KSC: $V \geq 800 \text{ mm (31 1/2")}$





Lite Glass / Lite Glass+

La línea **Lite Glass/Lite Glass+** conecta estancias mediante una puerta corredera. Ofrece numerosas configuraciones tales como puertas paralelas o enfrentadas.

Su perfil T permite una instalación empotrada en falso techo con perfil totalmente oculto. una vez instalado solo se aprecia una fina línea de sombra.

Sistema de frenado opcional con Lite Glass+ 100: **KSC** - Klein Soft Closing, detención suave controlada.

The **Lite Glass/Lite Glass+** line connects rooms with a sliding door. It offers numerous configurations, such as bi-passing or bi-parting doors.

Its T profile allows recessed drop ceiling installation with a completely hidden profile. Once installed, only a fine shadow can be seen.

Optional braking system with Lite Glass+ 100: **KSC** - Klein Soft Closing, smooth, controlled closing.

- Alu. Silver Mate
Alu. Silver Matte
- Alu. Negro Mate
Alu. Black Matte
- Alu. Bronce Mate
Alu. Bronze Matte

Peso máx./ Max. weight:	100 kg 220 lbs
Freno/ Brake:	KSC

LITE GLASS 60

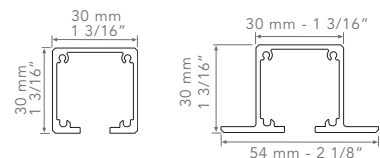

LITE GLASS / LITE GLASS+ 100

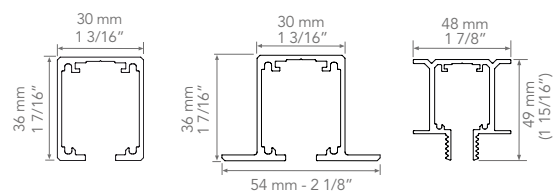



LITE GLASS 60

PERFIL TOP / TOP TRACK

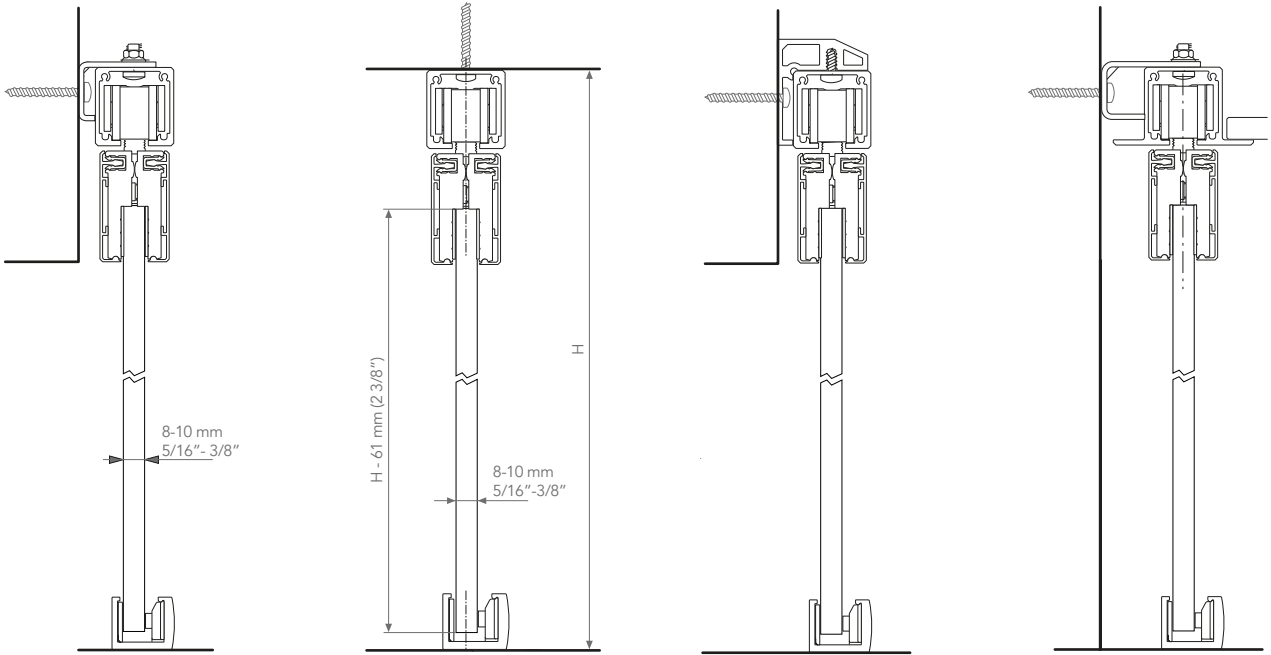

Soporte pared 17 mm /
Wall bracket 17 mm

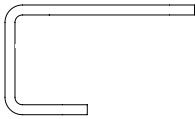

Soporte pared 6 mm /
Wall bracket 6mm

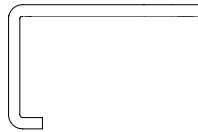

Perfil soporte pared 6 mm /
Wall bracket profile 6 mm

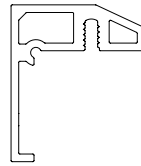

Perfil soporte pared 17 mm /
Wall bracket profile 17 mm

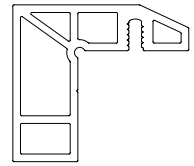

LITE GLASS / LITE GLASS+ 100

PERFIL TOP / TOP TRACK

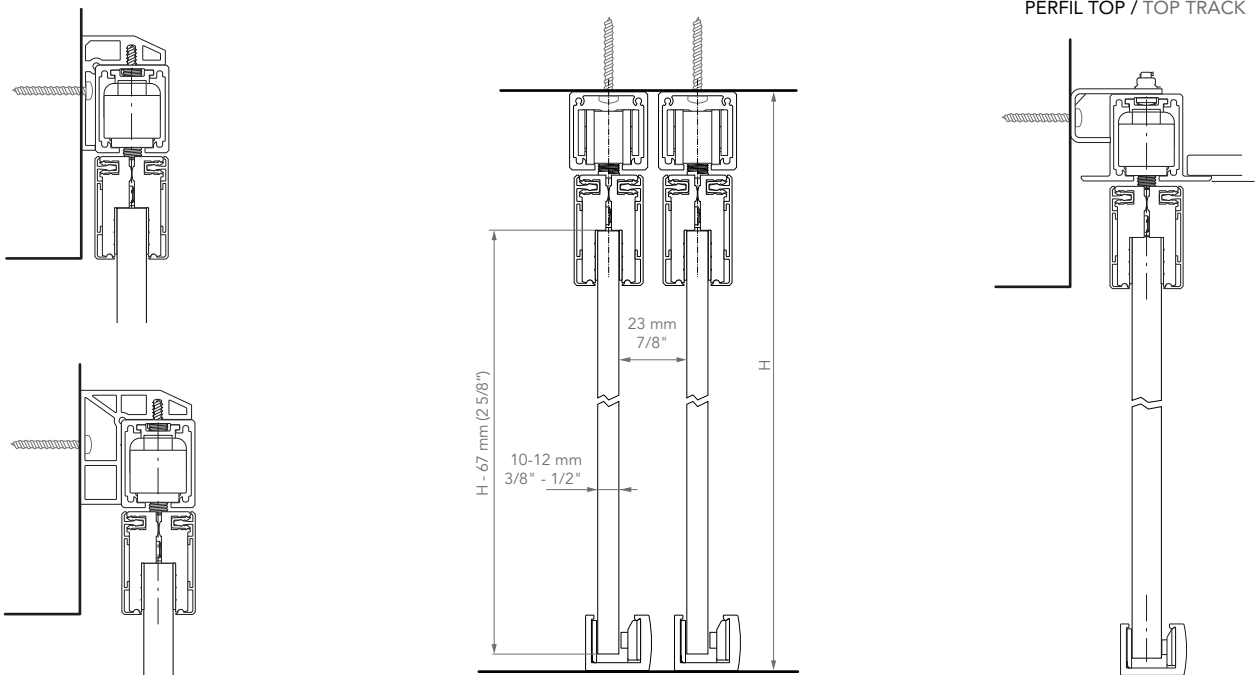

LITE GLASS+ T

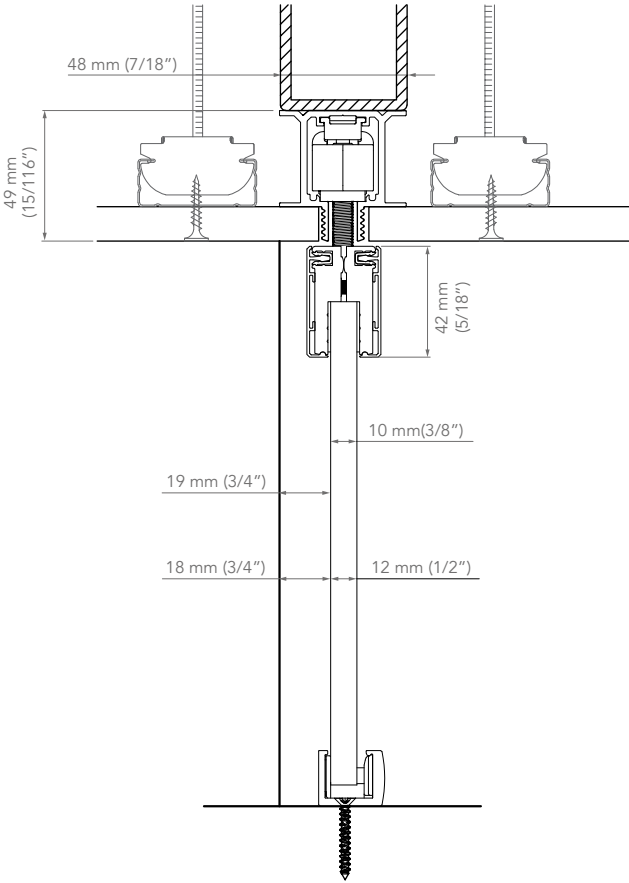
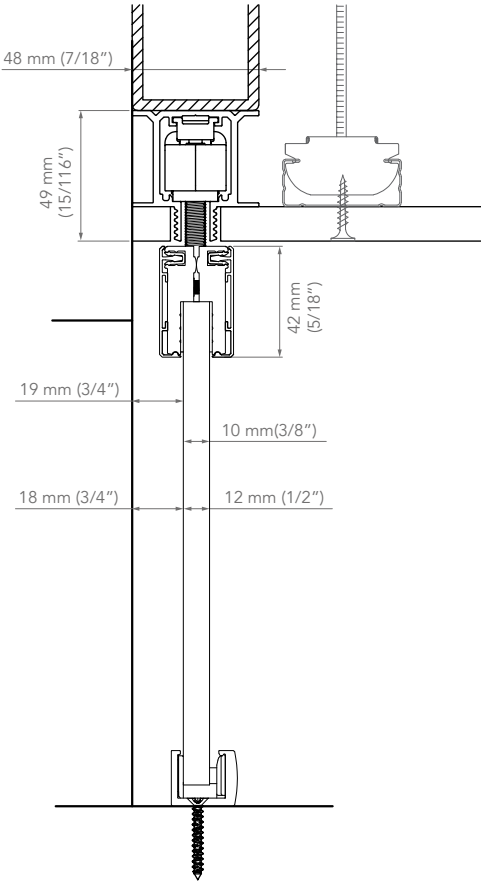









UNIKGLASS+ | Onside Arquitectura



Unikglass+ Air

Unikglass+ Air está diseñado para ser instalado sobre una pared de cristal, potenciando así la difusión de la luz natural. Es particularmente adecuado para estancias con techos altos y oficinas. Transparencia absoluta.

Instalación sobre pared de vidrio de 10 y 12 mm. Regulable en altura para facilitar la instalación.

Sistema de frenado de la puerta, a escoger:

KSC - Klein Soft Closing, detención suave controlada.

KBS - Klein Brake System, tope con freno amortiguador.

Unikglass+ Air is designed to be installed on a glass wall, boosting the diffusion of natural light. It is particularly well suited for offices and rooms with high ceilings. Total transparency.

Installation on 10 mm and 12 mm glass wall. Height adjustable for easy installation.

Door braking system, to be chosen from the following options:

KSC - Klein Soft Closing, smooth, controlled closing.

KBS - Klein Brake System, stop with damper brake.

● Alu. Silver Mate
Alu. Silver Matte

● Alu. Negro Mate
Alu. Black Matte

Peso máx./ Max. weight:	variable
----------------------------	----------

Freno/ Brake:	KSC KBS
------------------	------------

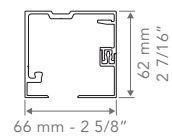

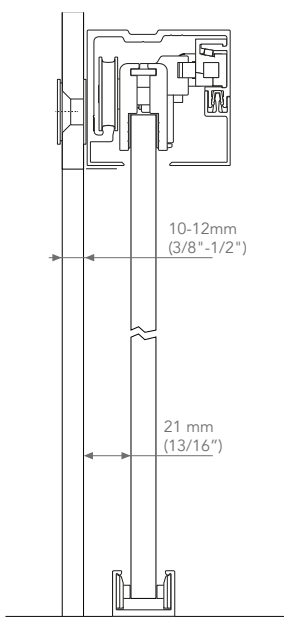

Gama	Perfil / Track	L
G1	2 m - 78"	Min. 820 mm Max. 970 mm Min. 32 5/16" Max. 38 3/16"
G2	2,5 m - 98"	Min. 1.020 mm Max. 1.220 mm Min. 40 3/16" Max. 48"
G3	3 m - 118"	Min. 1.300 mm Max. 1.470 mm Min. 51 3/16" Max. 57 7/8"

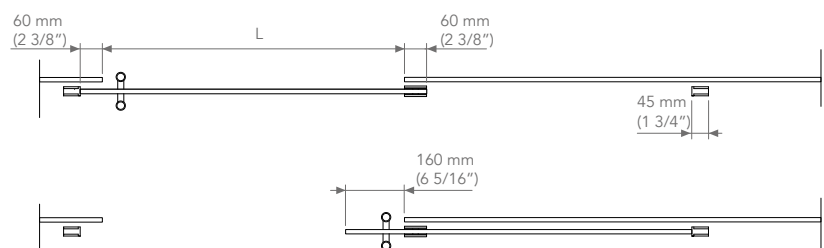



Extendo / Extendo Corner

Extendo está diseñado para crear espacios mediante un sistema de 2, 3 o 4 paneles correderos telescópicos y sincrónicos de cristal. Al mover una sola hoja, se genera el suave deslizamiento de las demás, sin esfuerzo. Particularmente adecuado para proyectos contemporáneos, permite una luz de paso de hasta 5,10 m. Su sistema de transmisión viene premontado de fábrica para agilizar el montaje.

Está también disponible en aplicación Corner, ideal para crear una estancia dentro de un espacio existente.

Extendo is designed to create spaces with a system of 2, 3 or 4 telescopic and synchronized sliding glass panels. When one sheet is moved, the others smoothly and effortlessly slide along with it. Particularly well suited to contemporary projects, it allows for passageways measuring up to 5.10 meters. Its transmission system comes pre-assembled from the factory to speed up the installation process.

It is also available as a corner application, perfect for creating a room within an existing space.

- Alu. Silver Mate
Alu. Silver Matte
- Alu. Negro Mate
Alu. Black Matte

Peso máx./ variable
Max. weight:

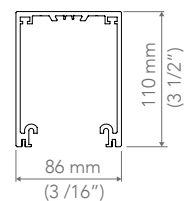



SIN VIDRIO FIJO / WITHOUT FIXED GLASS

CON VIDRIO FIJO / WITH FIXED GLASS

EMPOTRADO / RECESSED

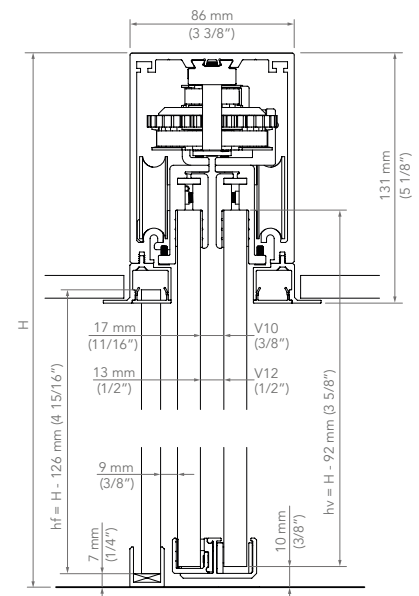
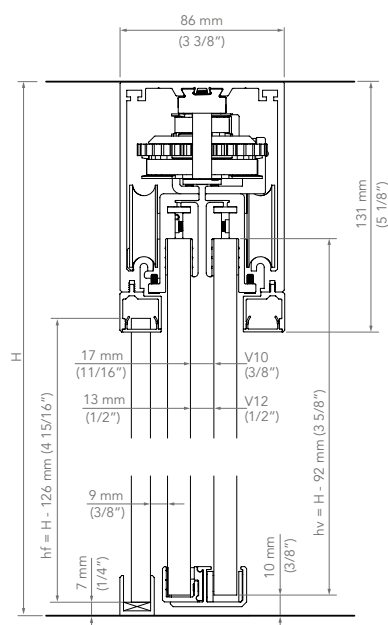
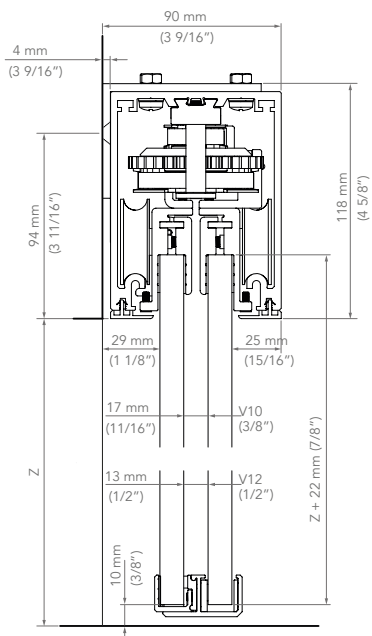

EXTENDO 2

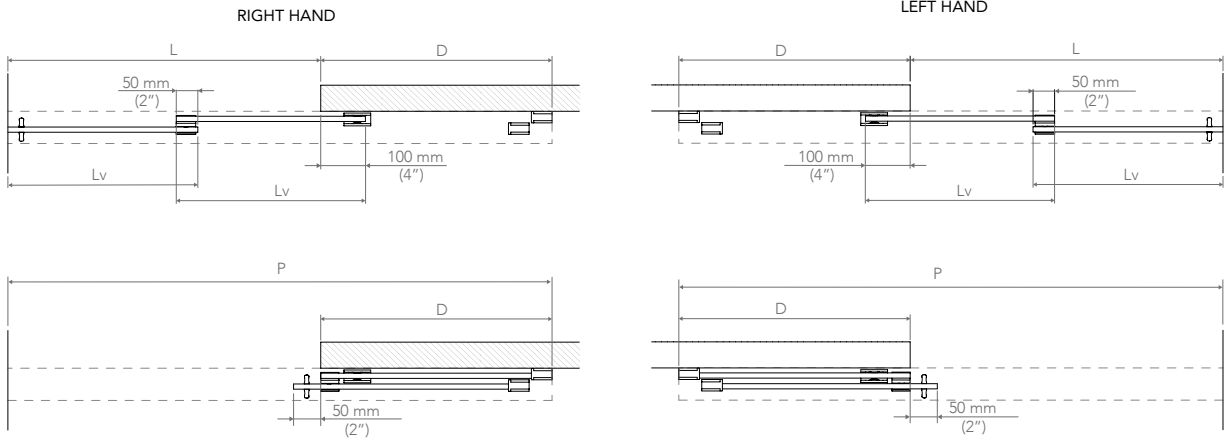

G	L	P
G1	1.300 - 1.550 mm / 51 1/4" - 60 1/1"	2.500 mm / 98"
G2	1.550 - 1.900 mm / 60 1/1" - 74 3/4"	3.000 mm / 118"
G3	1.900 - 2.200 mm / 74 1/1" - 86 5/8"	3.500 mm / 137"
G4	2.200 - 2.550 mm / 86 5/8" - 100 3/8"	4.000 mm / 157"

$L \leq \frac{2}{3} P - 85 \text{ mm (3 3/8")}$	$D \geq \frac{P}{3} + 85 \text{ mm (3 3/8")}$	$D \geq \frac{L}{2} + 125 \text{ mm (5")}$	$P = L + D$	$L_v = \frac{L}{2} + 75 \text{ mm (3")}$
---	---	--	-------------	--

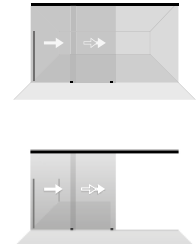

EXTENDO 2+2

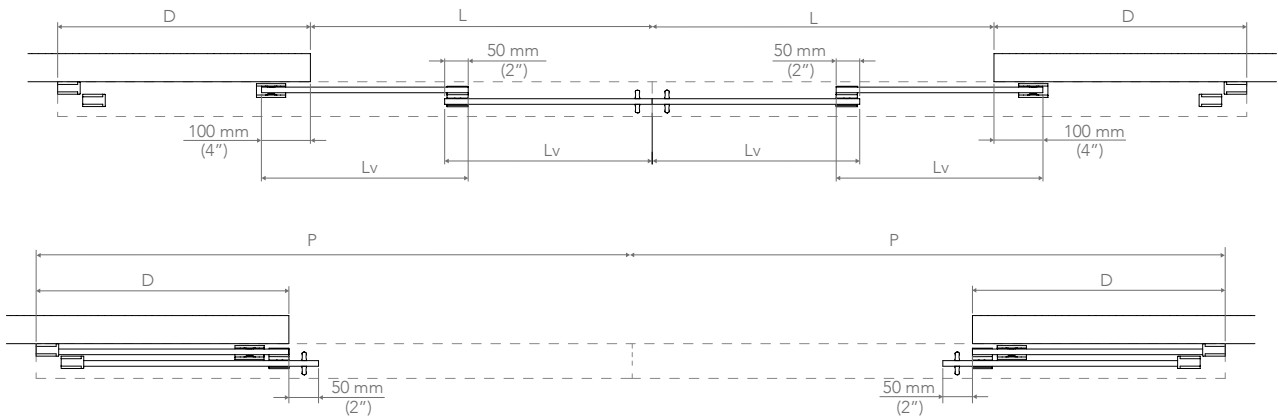

G	L	P
G1	1.300 - 1.550 mm / 51 1/4" - 60 1/1"	2.500 mm / 98"
G2	1.550 - 1.900 mm / 60 1/1" - 74 3/4"	3.000 mm / 118"
G3	1.900 - 2.200 mm / 74 1/1" - 86 5/8"	3.500 mm / 137"
G4	2.200 - 2.550 mm / 86 5/8" - 100 3/8"	4.000 mm / 157"

$L \leq \frac{2}{3} P - 170 \text{ mm (6 11/16")}$	$D \geq \frac{P}{6} + 85 \text{ mm (3 3/8")}$	$D \geq \frac{L}{4} + 125 \text{ mm (5")}$	$P = D \times 2 + L$	$L_v = \frac{L}{4} + 75 \text{ mm (3")}$
--	---	--	----------------------	--



EXTENDO 3

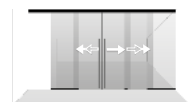
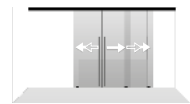
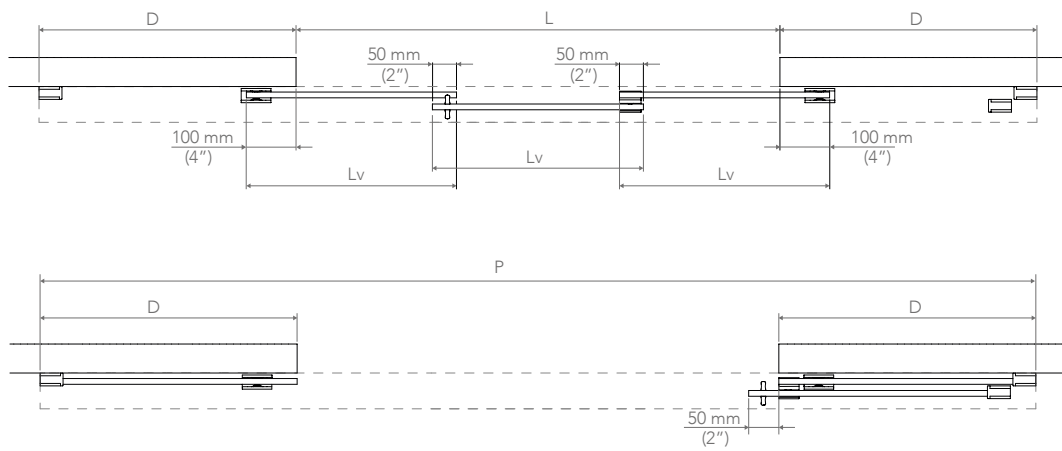

G	L	P
G1	1.725 - 2.175 mm / 67 7/8" - 85 5/8"	4.000 mm / 157"
G2	2.725 - 2.775 mm / 85 5/8" - 109 1/4"	5.000 mm / 196"

$L \leq \frac{3}{5} P - 180 \text{ mm (7 1/6")}$	$D \geq \frac{P}{5} + 90 \text{ mm (3 9/16")}$	$D \geq \frac{L}{3} + 150 \text{ mm (5 15/16")}$	$P = Dx2+L$	$Lv = \frac{L}{3} + 100 \text{ mm (4")}$
--	--	--	-------------	--

EXTENDO 4

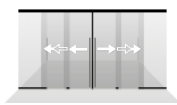
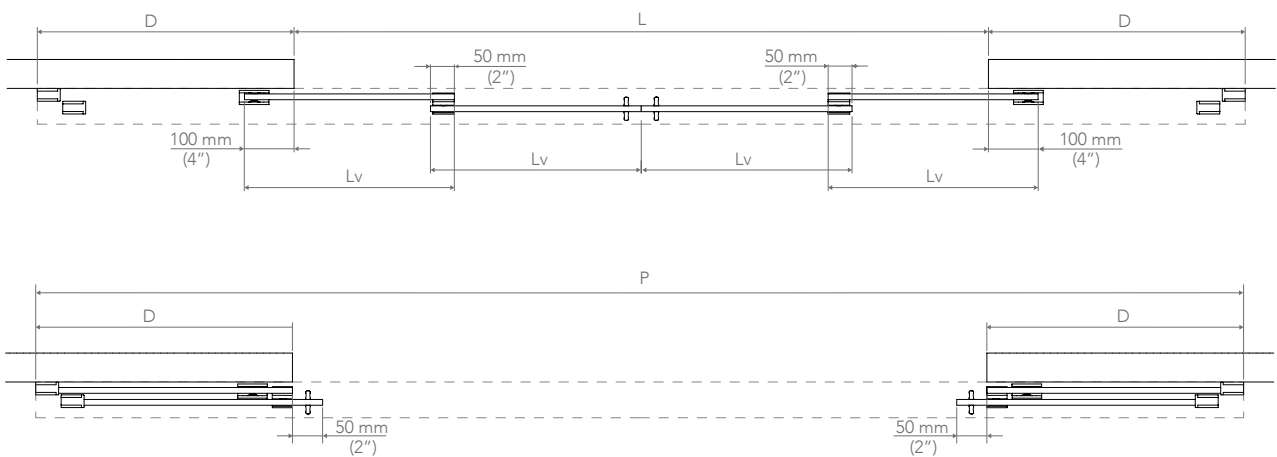

G	L	P
G1	2.400 - 3.100 mm / 94 1/2" - 122 1/16"	5.000 mm / 196"

$L \leq \frac{2}{3} P - 170 \text{ mm (6 11/16")}$	$D \geq \frac{P}{6} + 85 \text{ mm (3 3/8")}$	$D \geq \frac{L}{4} + 125 \text{ mm (5")}$	$P = Dx2+L$	$Lv = \frac{L}{4} + 75 \text{ mm (3")}$
--	---	--	-------------	---

EXTENDO CORNER

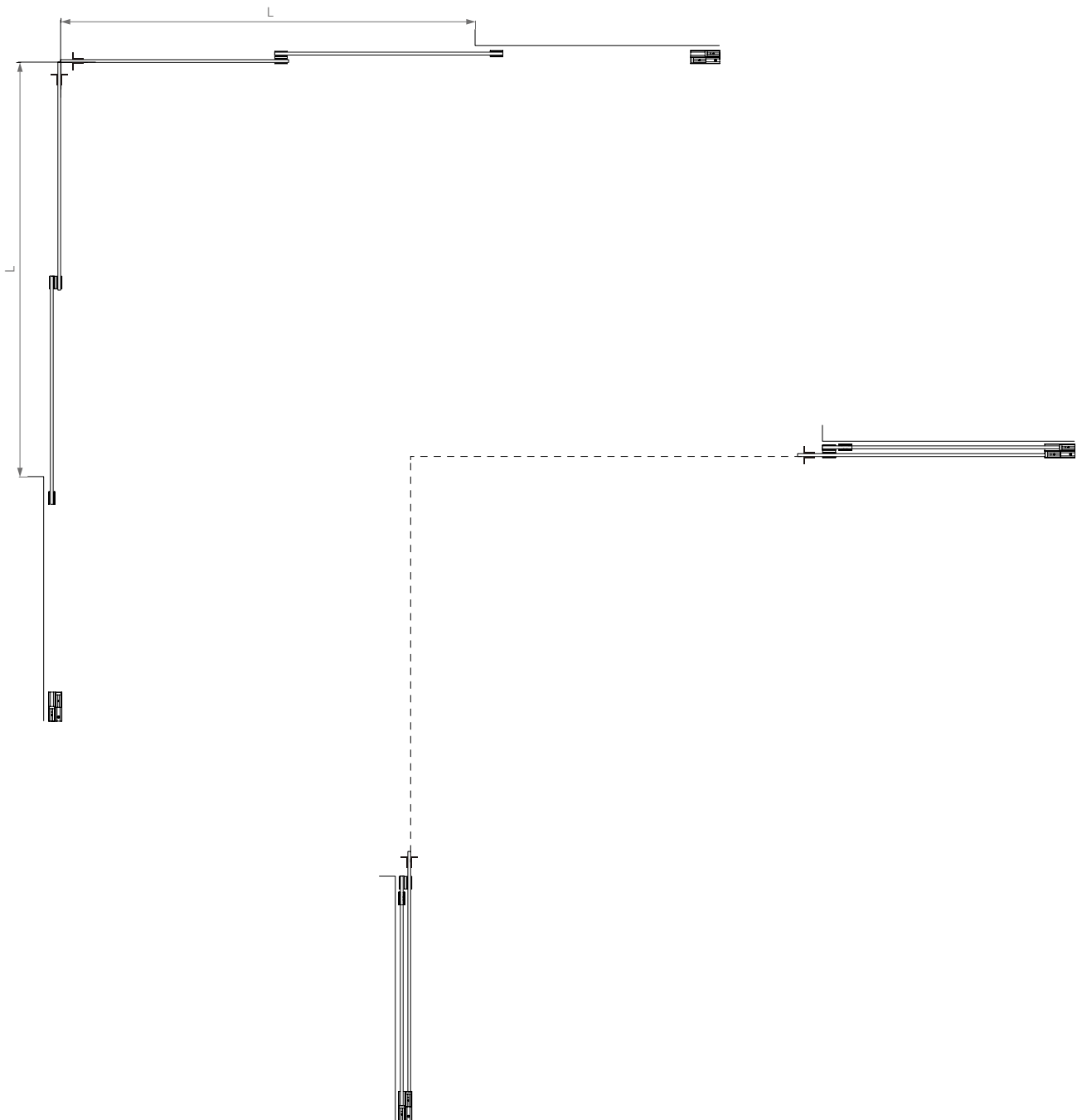

G	L		P		
G1	1.300 - 1.550 mm / 51 1/4" - 60 1/1"		2.500 mm / 98"		
G2	1.550 - 1.900 mm / 60 1/1" - 74 3/4"		3.000 mm / 118"		
G3	1.900 - 2.200 mm / 74 1/1" - 86 5/8"		3.500 mm / 137"		
G4	2.200 - 2.550 mm / 86 5/8" - 100 3/8"		4.000 mm / 157"		
$L \leq \frac{2}{3} P - 85 \text{ mm (3 3/8")}$		$D \geq \frac{P}{3} + 85 \text{ mm (3 3/8")}$	$D \geq \frac{L}{2} + 125 \text{ mm (5")}$	$P = L + D$	$L_v = \frac{L}{2} + 75 \text{ mm (3")}$

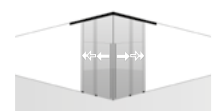
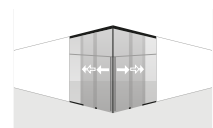





Panoramic

Panoramic es un sistema de frente acristalado de máxima calidad, diseñado para crear o reorganizar espacios interiores. Permite una gran flexibilidad de aplicaciones y ofrece prestaciones como retorno a 90° o perfilera superior e inferior empotrables. También tiene la posibilidad de doble vidrio fijo, de 12 ó 16 mm.

Incorpora juntas aislantes para una mayor privacidad.
Posibilidad de perfiles de falso techo para instalación por fases.
Otorga al arquitecto máxima libertad de diseño.

Panoramic is a glass front system of the highest quality, designed to create or reorganize interior spaces. It allows for a wide range of applications and offers features such as a 90° junction or recessed top and bottom profiles. It also offers the possibility of double fixed glass, measuring 12 mm or 16 mm.

It incorporates insulating joints for greater privacy.
Possibility of drop-ceiling profiles for phased installation.
It gives the architect maximum freedom when designing.

- Alu. Silver Mate
- Alu. Silver Matte

Peso máx./ 120 kg
Max. weight: 264 lbs

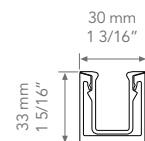
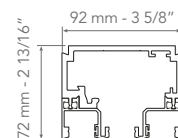



DOBLE VIDRIO FIJO / DOUBLE FIXED GLAZING

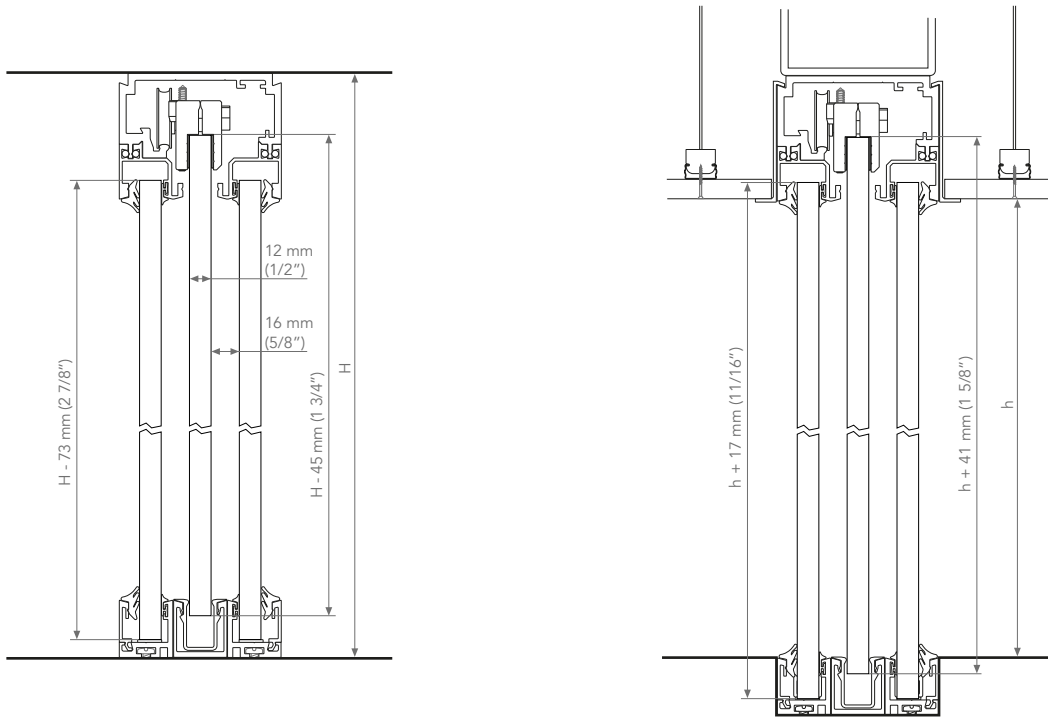

UN VIDRIO FIJO / SINGLE FIXED GLAZING

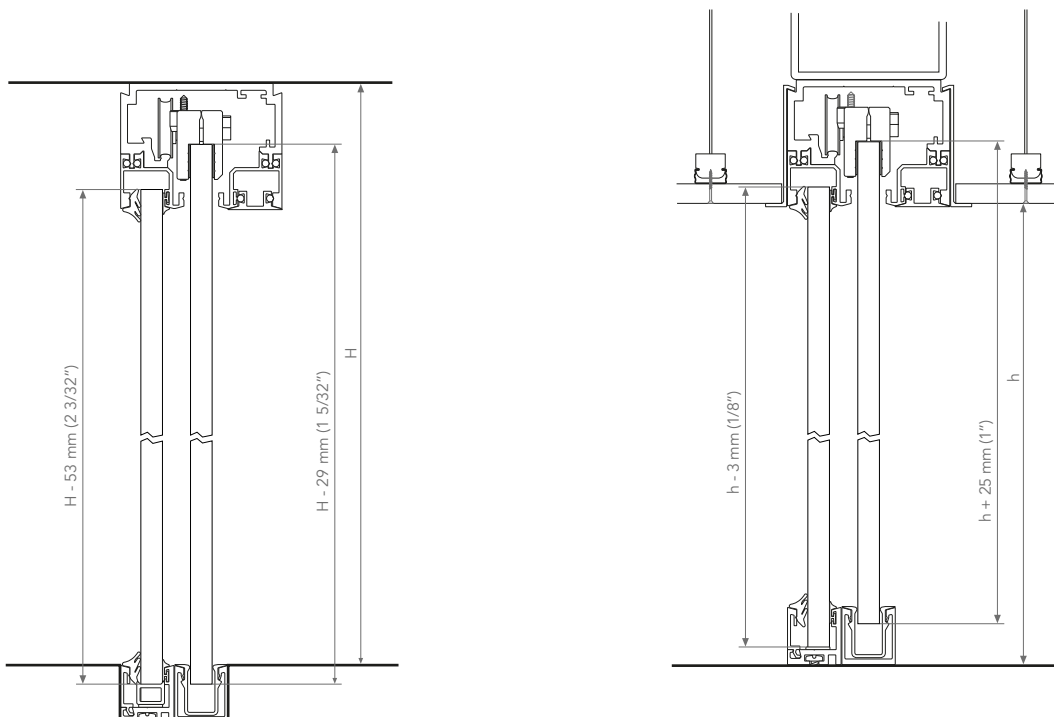

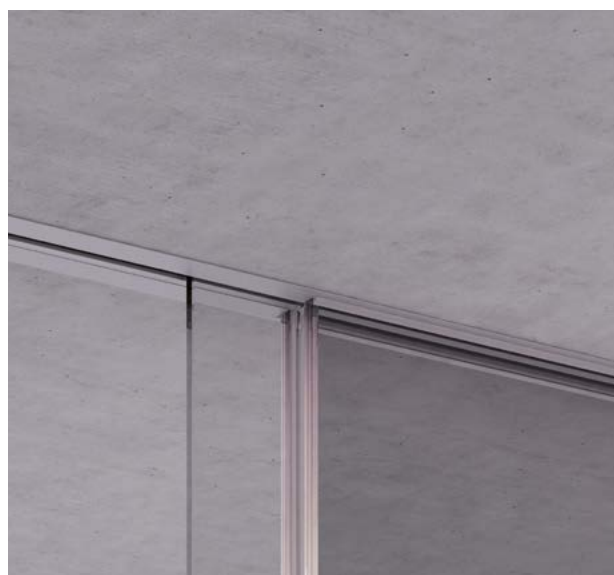



Pocket Glass

Pocket Glass está diseñado para conectar ambientes a través de una o varias puertas correderas de cristal, con perfil empotrado o visto.

Dos versiones dejan patente su versatilidad: un diseño limpio, sin ningún herraje a la vista, y un diseño comercial, con mordazas expuestas.

Sistema de sujeción de la puerta a escoger: mediante mordazas de presión cortas o largas.

Pocket Glass is designed to connect rooms with one or several sliding glass doors, with a recessed or exposed profile.

Two versions make its versatility clear: a clean design, without any fittings in sight, and a commercial design, with exposed clamps.

Door fastening system to be chosen from the following: short or long pressure clamps.

- Alu. Silver Mate
- Alu. Silver Matte

Peso máx./ 150 kg
Max. weight: 330 lbs

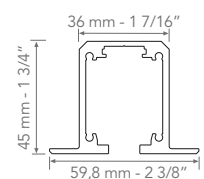
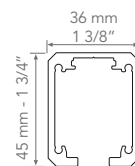



VISTO / EXPOSED

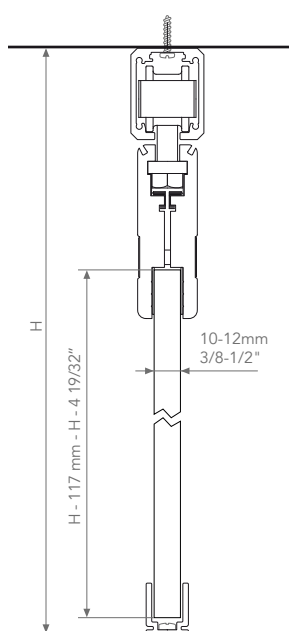

EMPOTRADO / RECESSED

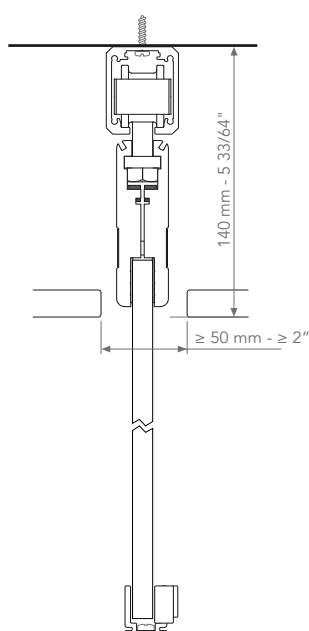

EMPOTRADO / RECESSED
PERFIL TOP / TOP TRACK

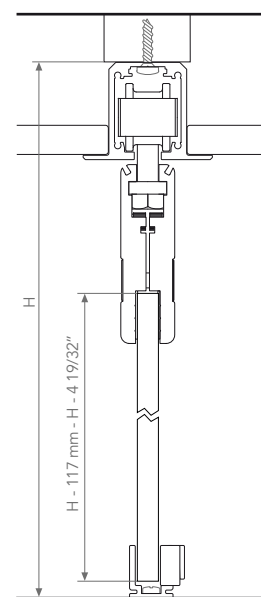



Rollglass

Rollglass crea espacios mediante un frente acristado que combina paneles fijos y correderos en un único perfil, reafirmando así la sencillez de la instalación y minimizando el espacio entre hoja corredera y vidrio fijo.

Disponible con o sin perfil inferior para el vidrio fijo.

Rollglass creates spaces with a glass front that combines fixed and sliding panels on a single profile, resulting in a simple installation and minimizing the gap between the fixed and sliding glass panels.

Available with or without a bottom profile for the fixed glass.

● Alu. Silver Mariner
Alu. Silver Mariner

Peso máx./ 40 kg
Max. weight: 88 lbs

ROLLGLASS 40

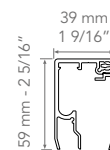



ROLLGLASS 40

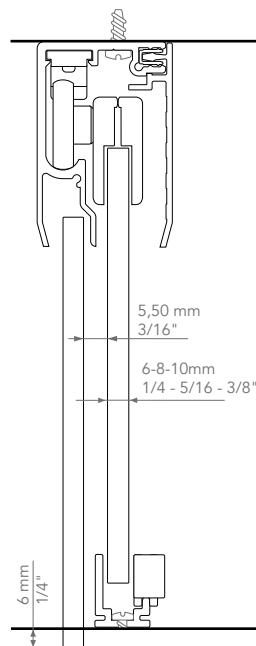



Rollglass Autoportante

Rollglass Autoportante se fija en paredes paralelas y divide espacios mediante un frente acristalado que combina panel fijo y puerta corredera. La mínima separación entre vidrio fijo y corredero aumenta la estética del conjunto.

Su versión Expert resulta ideal en aplicaciones para duchas debido a su guiador especial.

Rollglass Self-Supporting (Autoportante) attaches to parallel walls and divides spaces with a glass front that combines fixed panels and sliding doors. The minimal gap between the fixed and sliding glass strengthens the structure's aesthetic.

Given its special guide, the Expert version is ideal for applications in showers.

- Alu. Silver Mate
- Alu. Silver Matte

Peso máx./ 40 kg
Max. weight: 88 lbs

ROLLGLASS AUTO 40

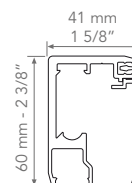



40 BASIC

40 EXPERT A

40 EXPERT B

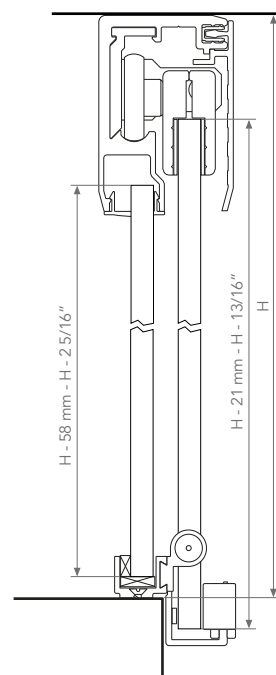
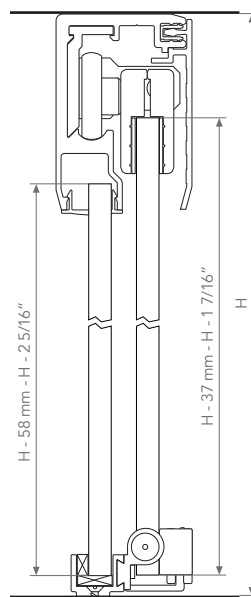
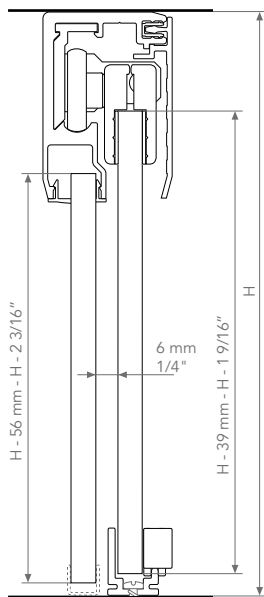





EXTENDO CORNER | Studio DSGN



Rolmatic / Rolmatic Corner

Rolmatic crea espacios mediante un frente acristalado con dos puertas enfrentadas sincronizadas que se deslizan sobre vidrios fijos. Existe en aplicación Corner.

La mínima separación entre cristal fijo y corredor realza el diseño minimalista del conjunto. Ofrece una luz de paso de hasta 2,50 metros. Su sistema de transmisión premontado garantiza un montaje fácil. Movimiento preciso sin ajuste de sincronización.

Rolmatic creates spaces using a glass front with two synchronized bi-parting doors that slide over fixed glass panels. It is also available as a corner application.

The minimal gap between the fixed and sliding glass enhances the minimalist design of the structure. It offers a passageway measuring up to 2.50 meters. Its pre-assembled transmission system guarantees an easy assembly. Precise movement without any synchronization adjustment.

● Alu. Silver Mate
Alu. Silver Matte

Peso máx./ variable
Max. weight:

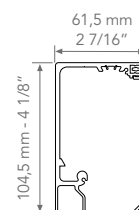

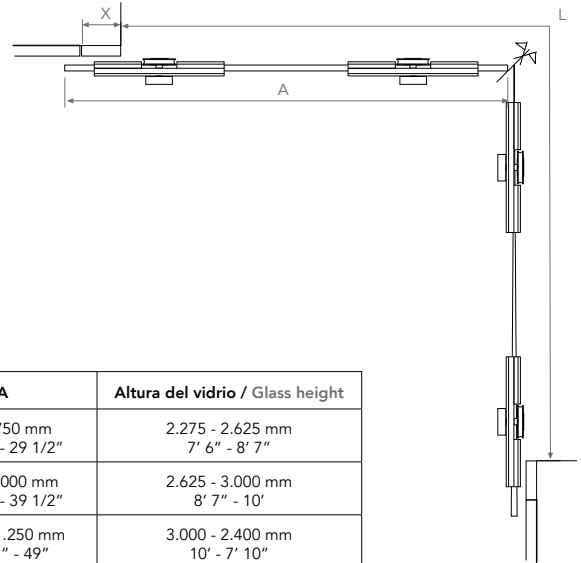
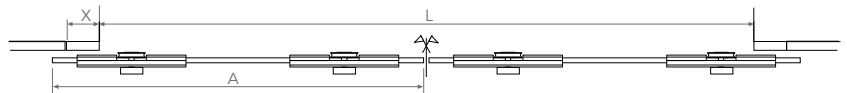
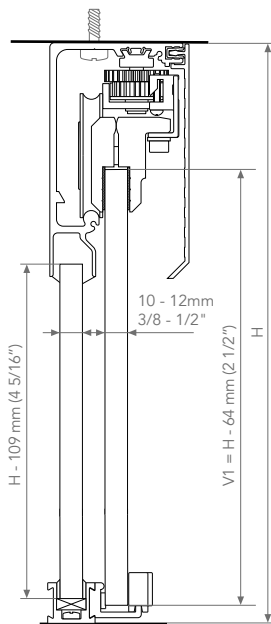

Gama	Perfil / Track	A	Altura del vidrio / Glass height
G1	3.000 mm 118"	650 - 750 mm 25 1/2" - 29 1/2"	2.275 - 2.625 mm 7' 6" - 8' 7"
G2	4.000 mm 157"	750 - 1.000 mm 29 1/2" - 39 1/2"	2.625 - 3.000 mm 8' 7" - 10'
G3	5.000 mm 196"	1.000 - 1.250 mm 39 1/2" - 49"	3.000 - 2.400 mm 10' - 7' 10"



Unikmatic / Unikmatic Corner

Unikmatic conecta ambientes mediante dos paneles correderos enfrentados de cristal, que se deslizan simultáneamente de cada lado al accionar uno de ellos.

Existe en aplicación Corner. Permite conseguir una apertura de hasta 2,50 m. Su sistema de transmisión premontado garantiza un montaje rápido. Movimiento preciso sin ajuste de sincronización.

Unikmatic connects rooms with two bi-parting sliding glass panels that simultaneously slide to either side when one of them is moved.

It is also available as a corner application. It allows you to achieve an opening of up to 2.50 meters. Its pre-assembled transmission system guarantees a quick assembly. Precise movement without any synchronization adjustment.

● Alu. Silver Mate
Alu. Silver Matte

Peso máx./ variable
Max. weight:

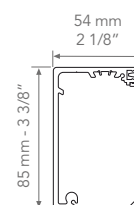

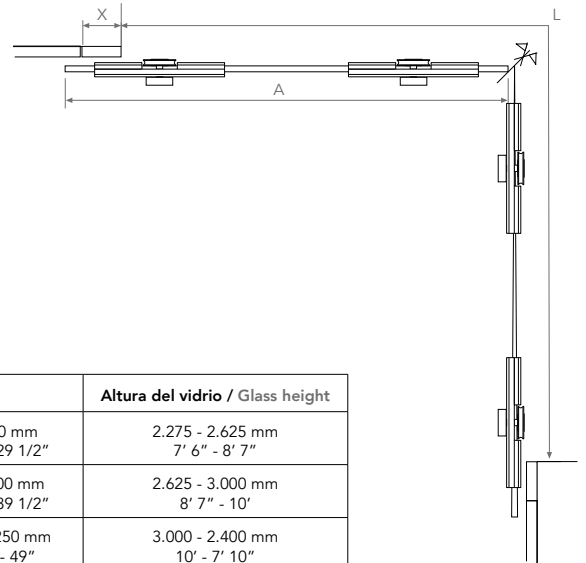
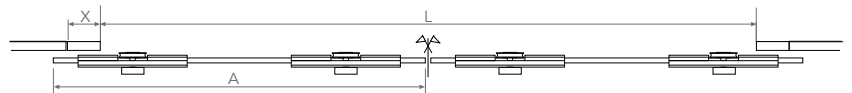
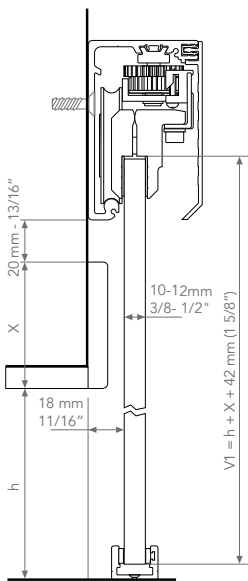

Gama	Perfil / Track	A	Altura del vidrio / Glass height
G1	3.000 mm 118"	650 - 750 mm 25 1/2" - 29 1/2"	2.275 - 2.625 mm 7' 6" - 8' 7"
G2	4.000 mm 157"	750 - 1.000 mm 29 1/2" - 39 1/2"	2.625 - 3.000 mm 8' 7" - 10'
G3	5.000 mm 196"	1.000 - 1.250 mm 39 1/2" - 49"	3.000 - 2.400 mm 10' - 7' 10"







Unikself

Unikself conecta espacios mediante un panel corredero de cristal con autocierre avanzado "self closing", de velocidad constante y controlada. Su galería clipada y el sistema de transmisión premontado aseguran una fácil instalación.

Unikself connects spaces through a sliding glass panel with an advanced self-closing feature, which operates at a steady, controlled speed. Its clipped valance and pre-assembled transmission system ensure an easy installation.

● Alu. Silver Mate
Alu. Silver Matte

Peso máx./ variable
Max. weight:

Freno/ SELF
Brake:

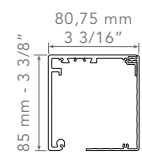

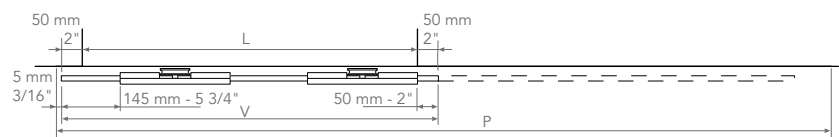
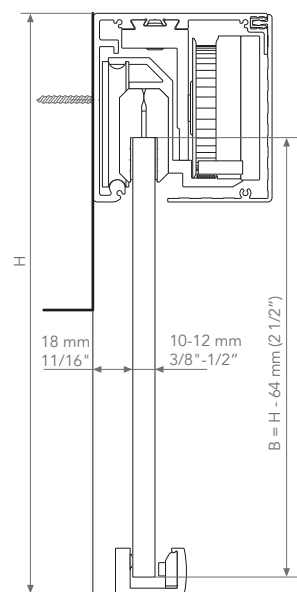

Gama	L	V	P0	P
G1	900 mm - 1.150 mm 35 1/2" - 45"	L + 100 mm L + 4"	2.500 mm 98"	2L + 160 mm 2L + 6 5/16"
G2	1.150 mm - 1.500 mm 45" - 59"		3.000 mm 118"	



Unikair Self

Unikair Self conecta espacios mediante un sistema fijado a una pared de cristal, guiando una puerta corredera de vidrio con autocierre avanzado, de velocidad constante y controlada.

Sistema de transmisión premontado que asegura una instalación fácil. Máxima transparencia y modernidad.

Unikair Self connects spaces with a system attached to a glass wall, guiding a sliding glass door with an advanced self-closing feature, which operates at a study, controlled speed.

Pre-assembled transmission system ensures an easy installation. Maximum transparency and modernity.

- Alu. Silver Mate
- Alu. Silver Matte

Peso máx./ variable
Max. weight:

Freno/ SELF
Brake:

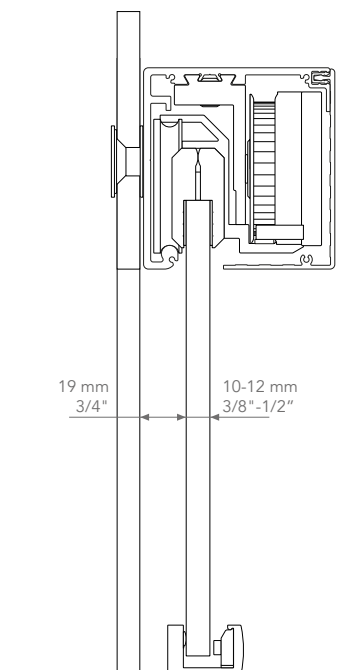
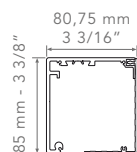



Unikmatic Air

Unikmatic Air crea espacios mediante un sistema fijado a una pared de cristal que guía dos paneles de vidrio correderos enfrentados con apertura sincrónica, de manera que se deslicen simultáneamente hacia cada lado. Apertura de hasta 2,50 m. Su sistema de transmisión premontado y pretensado garantiza un montaje rápido. Movimiento preciso sin ajuste de sincronización.

Máxima difusión de luz natural, máxima comodidad.

● Alu. Silver Mate
Alu. Silver Matte

Unikmatic Air creates spaces with a system attached to a glass wall that guides two bi-parting sliding glass panels with synchronized opening, so that they simultaneously slide to either side. Opening up to 2.50 meters. Its pre-assembled and pre-tightened transmission system guarantees a quick assembly. Precise movement without any synchronization adjustment.

Maximum diffusion of natural light, maximum comfort.

Peso máx./ variable
Max. weight:

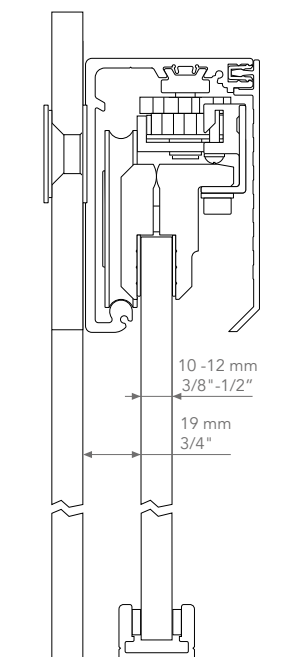
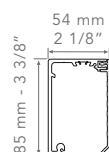



Rollglass Self

Rollglass Self crea espacios mediante un frente acristado que combina paneles fijos y móviles y dispone de un mecanismo de autocierre "self closing", de velocidad constante y controlada.

Un único perfil aloja tanto los paneles fijos como los correderos: asegura la sencillez de la instalación y minimiza los espacios entre vidrios.

Rollglass Self creates spaces with a glass front that combines fixed and mobile panels and has a self-closing mechanism, which operates at a steady, controlled speed.

Both the fixed and sliding panels are located on a single profile, ensuring a simple installation and minimizing the gap between the glass panels.

● Alu. Silver Mate
Alu. Silver Matte

Peso máx./ variable
Max. weight:

Freno/ SELF
Brake:

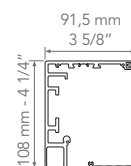

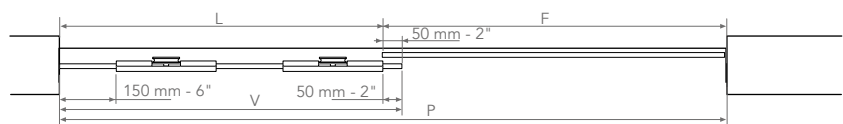
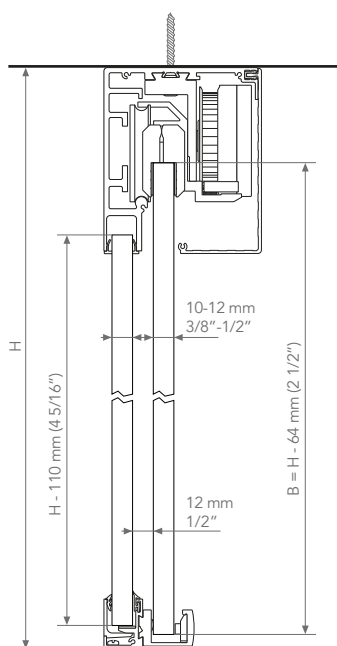

Gama	P	L min	V	F
G1	1.650 mm - 2.000 mm 65" - 78"	800 mm 32"	V=L+50 mm V=L+2"	F=P-L
G2	2.000 mm - 2.500 mm 79" - 98"			
G3	2.500 mm - 3.000 mm 99" - 118"			



KT Glass

KT Glass está diseñado para la instalación de un panel de vidrio mediante un sistema de sujeción tradicional, acorde con un diseño industrial. La versión **KT Glass 80** requiere la instalación de un embellecedor para ocultar el mecanismo.

KT Glass is designed for the installation of a glass panel with a traditional fastening system, suitable for an industrial design. The **KT Glass 80** version requires the installation of a decorative cover to hide the mechanism.

● Alu. Silver Mate
Alu. Silver Matte

Peso máx./ 180 kg
Max. weight: 396 lbs

KT GLASS 80

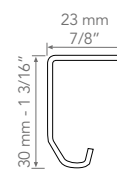

KT GLASS 180 EXPERT

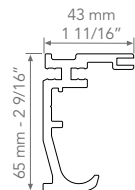



KT GLASS 80

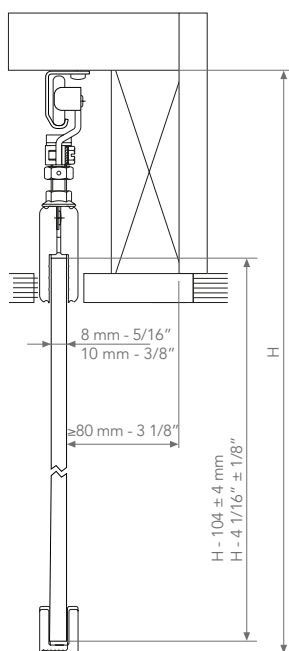

KT GLASS 180 EXPERT

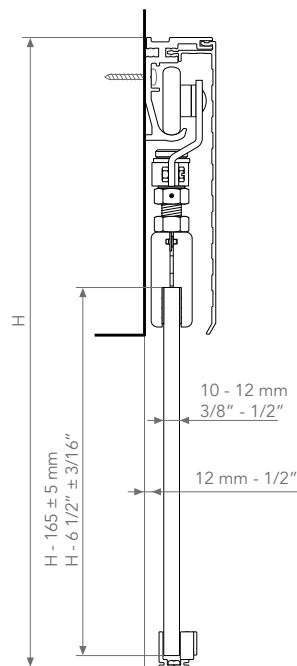

KT GLASS 180 EXPERT

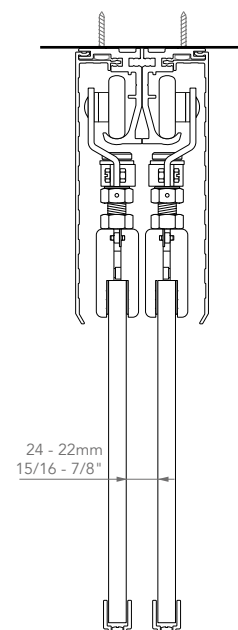



NK Glass

NK Glass está diseñado para la instalación de un panel de vidrio corredero con sistema de sujeción superior tradicional. Requiere la instalación de un embellecedor para ocultar el mecanismo.

NK Glass is designed for the installation of a sliding glass panel with a traditional upper fastening system. It requires the installation of a decorative cover to hide the mechanism.

- Alu. Silver Mate
- Alu. Silver Matte

Peso máx./ 80 kg
Max. weight: 176 lbs

NK GLASS 45

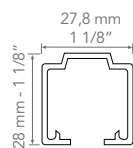

NK GLASS 80

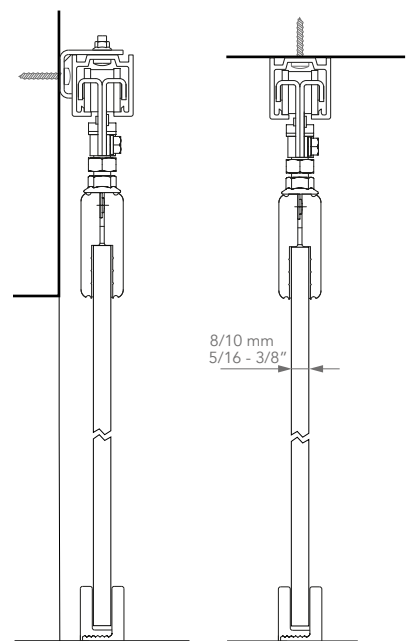
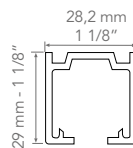



Clos Glass

Clos Glass está diseñado para dar acceso a espacios de almacenamiento mediante dos paneles de vidrio correderos paralelos. Requiere la instalación de un embellecedor para ocultar el mecanismo.

Clos Glass is designed to provide access to storage areas with two bi-passing sliding glass panels. It requires the installation of a decorative cover to hide the mechanism.

- Alu. Silver Mate
- Alu. Silver Matte

Peso máx./ 80 kg
Max. weight: 176 lbs

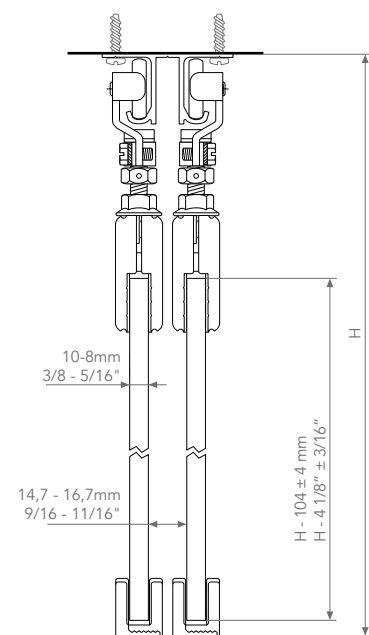
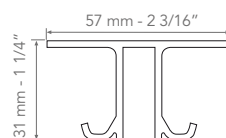



Stockglass

Stockglass permite abrir espacios mediante paneles de vidrio correderos que se apilan perpendicular o paralelamente. Puede disponer de cerradura para cada panel, lo que lo convierte en ideal para zonas comerciales. Configuración con una o dos zonas de aparcamiento.

Aprovechamiento óptimo de la luz de paso.

Stockglass allows you to open up spaces with sliding glass panels that are stacked in either a perpendicular or parallel configuration. Each panel can include its own lock, making this an ideal option for commercial areas. Configuration with one or two areas for storing open doors.

Optimal use of passageway.

- Alu. Silver Mate
- Alu. Silver Matte

Peso máx./ 150 kg
Max. weight: 330 lbs

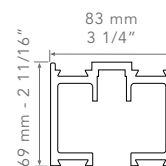

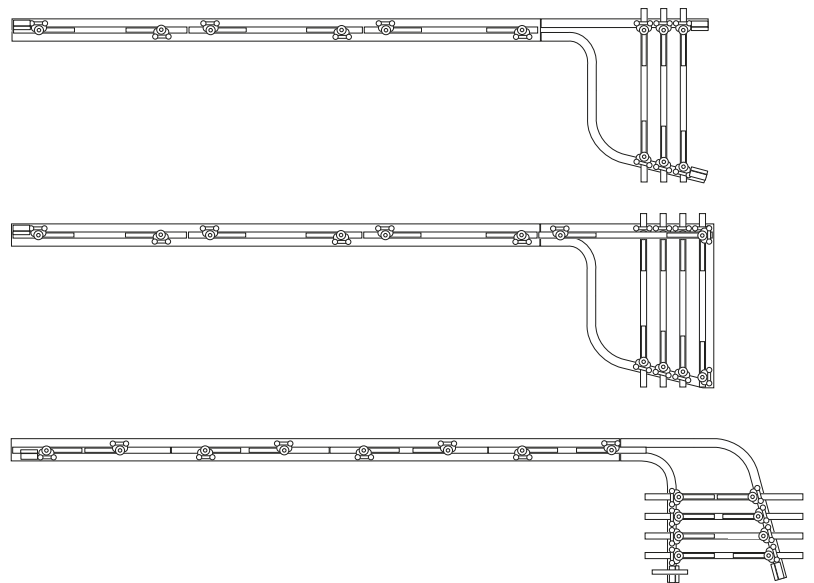
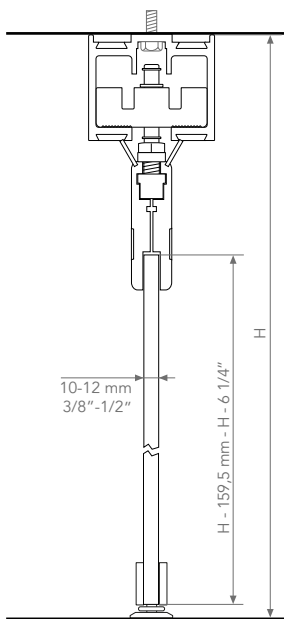



ROLLGLASS+ | Ros + Falguera Arquitectura







INTERIORISMO **MADERA**

Wood Interior Design



Madera: Calidez y personalización

Wood: Warmth and customization

ESPACIOS EN MOVIMIENTO

¿Son puertas o son tabiques? ¿Son conectores o transformadores de espacios? Son un mundo de posibilidades.

Los paneles móviles de madera conforman estancias flexibles en las que la carpintería interior se convierte en elemento protagonista. La belleza y nobleza del material, así como la variedad de sus acabados y formatos, liberan la creatividad.

La madera de suelo a techo, sin guías en el pavimento, se desliza con suavidad, actuando como mágica transformadora de su entorno. Formatos espectaculares que aumentan y realzan la calidad del espacio.

SPACES IN MOVEMENT

Are they doors or partitions? Do they connect or transform spaces? They are a world of possibilities.









Mobile wood panels create flexible rooms in which the interior woodwork becomes the protagonist. The beauty and elegance of this material, as well as the variety of finishes and sizes available, allow your creativity to flourish.

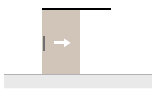

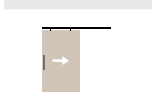
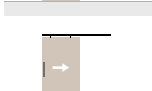
Floor-to-ceiling wood, without floor tracks, slides along smoothly, transforming its surroundings as if through magic. Spectacular sizes that increase and enhance the quality of the space.

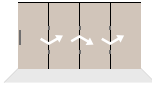
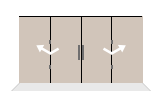
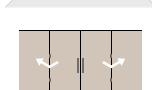
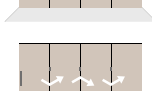

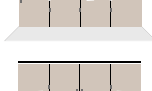

SLID TOP | Arquitectura-G

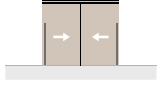
APLICACIÓN/ APPLICATION	PRODUCTO/ PRODUCT	PÁG./ PAGE	PESO*/ WEIGHT*		FRENO BRAKE			INSTALACIÓN MOUNTING		
			≤100	>100	KBS	KSC	SELF	PARED WALL	TECHO CEILING	EMPOTRABLE RECESSED
PUERTAS CORREDERAS ÚNICAS/ SINGLE SLIDING DOORS		LITE	120	●				●	●	●
		LITE+	120	●		●		●	●	●
		SLID	128	●	●		●	●		●
		SENSUS	140	●					●	
		NK	144	●				●	●	
		KT	146	●	●			●	●	
PUERTAS PLEGABLES/ FOLDING DOORS		SLID FOLD	132		●				●	●
		SLID PAR	136		●				●	●
		LITE PAR	148	●					●	●
		LITE FOLD	150	●					●	●
		NK FOLD	154	●				●	●	
		NK PAR	155	●					●	
		KP	156	●				●	●	

APLICACIÓN/ APPLICATION	PRODUCTO/ PRODUCT	PÁG./ PAGE	PESO*/ WEIGHT*		FRENO BRAKE			INSTALACIÓN MOUNTING		
			≤100	>100	KBS	KSC	SELF	PARED WALL	TECHO CEILING	EMPOTRABLE RECESSED
PUERTAS PARALELAS/ BI-PASSING DOORS		LITE	120	●				●	●	●
		LITE+	120	●		●		●	●	●
PUERTAS APILABLES/ STACKABLE DOORS		STOCKPANEL	158	●	●				●	

* Su peso se calcula en base a la siguiente fórmula: Altura [m] x Ancho [m] x Espesor [mm] x Densidad = Peso [kg]

* The weight is calculated based on the following formula: Height [m] x Width [m] x Thickness [mm] x Density = Weight [kg]



Lite / Lite+

La línea **Lite / Lite+** conecta estancias mediante un panel corredero de madera. Ofrece numerosas configuraciones como puertas paralelas o enfrentadas. Existen 2 tipos de herrajes: Superior (visto) y Retrac (oculto en el panel). Su versión Top permite empotrar el perfil a falso techo.

Su perfil T permite una instalación empotrada en falso techo con perfil totalmente oculto. una vez instalado solo se aprecia una fina línea de sombra.

Sistema de frenado opcional para Lite+ 100: **KSC** - Klein Soft Closing, detención suave controlada.

- Alu. Silver Mate
Alu. Silver Matte
- Alu. Negro Mate
Alu. Black Matte
- Alu. Bronce Mate
Alu. Bronze Matte

The **Lite / Lite+** line connects rooms with a sliding wood panel. It offers numerous configurations, such as bi-passing or bi-parting doors. There are two types of fittings: Superior (exposed) and Retrac (hidden in the panel). The Top version allows the profile to be recessed in a drop ceiling.

Its T profile allows recessed drop ceiling installation with a completely hidden profile. Once installed, only a fine shadow can be seen.

Optional braking system for Lite+ 100: **KSC** - Klein Soft Closing, smooth, controlled closing.

Peso máx./ Max. weight:	100 kg 220 lbs
Freno/ Brake:	KSC

LITE 60

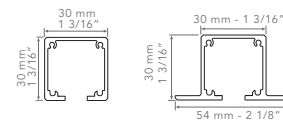

LITE / LITE+ 100

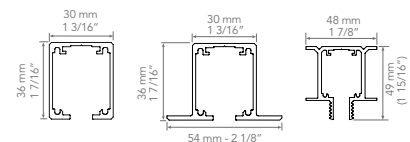



LITE 60

SUPERIOR

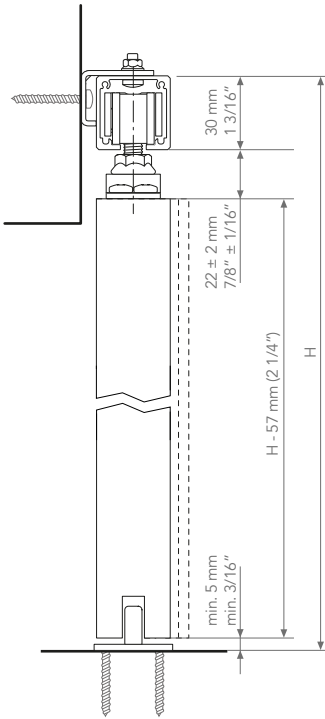

Soporte pared 17 mm /
Wall bracket 17 mm

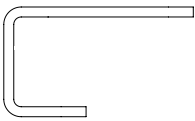

RETRAC

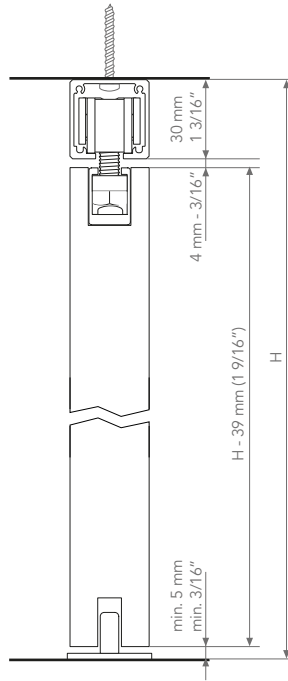

Soporte pared 6 mm /
Wall bracket 6 mm

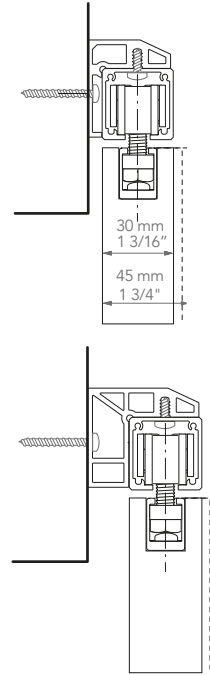
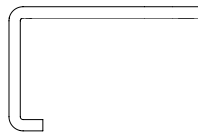

Perfil soporte pared 6 mm /
Wall bracket profile 6 mm

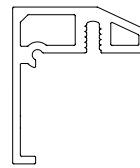

TOP

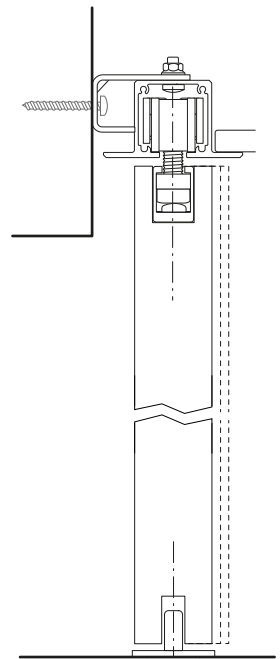

Perfil soporte pared 17 mm /
Wall bracket profile 17 mm

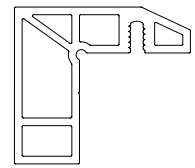

LITE 100 / LITE+ 100

SUPERIOR

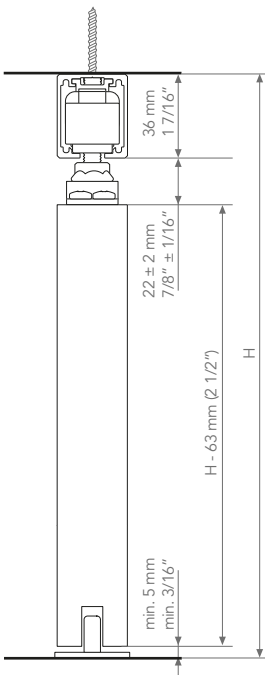

RETRAC

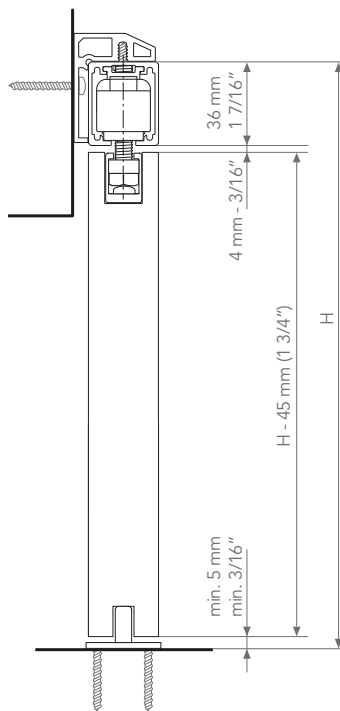

TOP

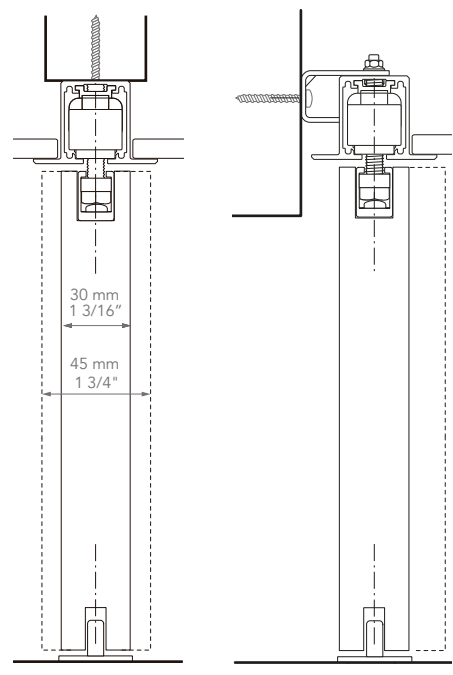

LITE+ T

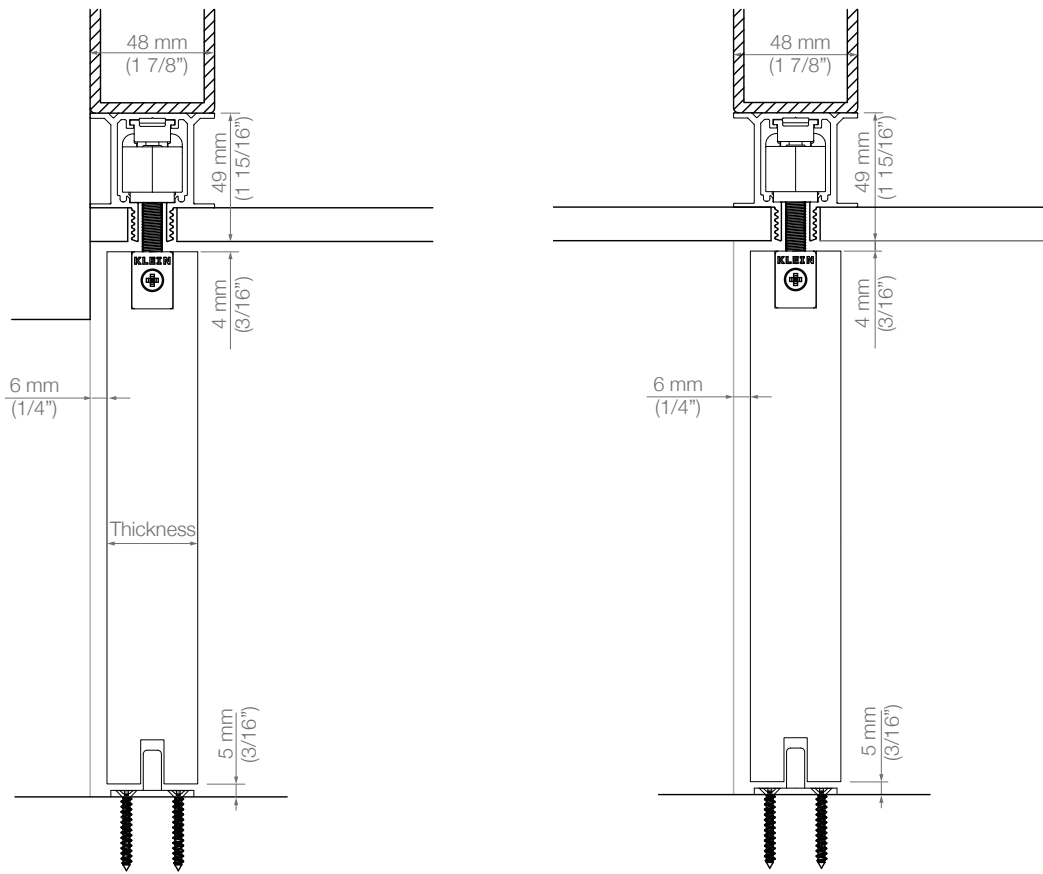









LITE+ | Roman Izquierdo Bouldstridge



Slid

Slid está diseñado para dividir ambientes mediante paneles de madera o de metal. Un deslizamiento suave y sin esfuerzo.

Ofrece numerosas configuraciones, tales como puertas paralelas, enfrentadas o Corner. Existen 2 tipos de herrajes: Superior (visto) y Retrac (oculto en el panel). El perfil Top permite empotrar el perfil a falso techo. Su versión Intra permite colocar el panel entre paredes.

Tabiques móviles, transformadores de espacios interiores.

Slid is designed to divide spaces with wood or metal panels. Smooth, effortless sliding.

It offers numerous configurations, such as bi-passing, bi-parting doors or corner doors. There are two types of fittings: Superior (exposed) and Retrac (hidden in the panel). The Top profile allows the profile to be recessed in the drop ceiling. The Intra version allows the panel to be installed between walls.

Mobile partitions that transform interior spaces.

● Alu. Silver Mate
Alu. Silver Matte

Peso máx./ 150 kg
Max. weight: 330 lbs

Freno/ KSC
Brake:

SLID 150

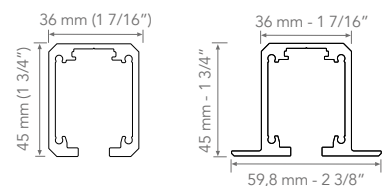



SUPERIOR

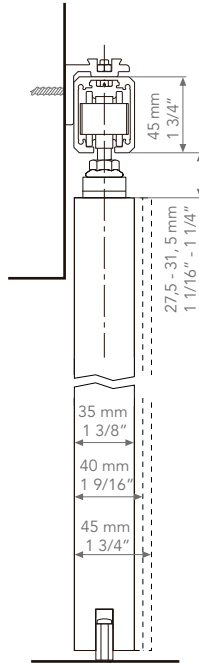

RETRAC

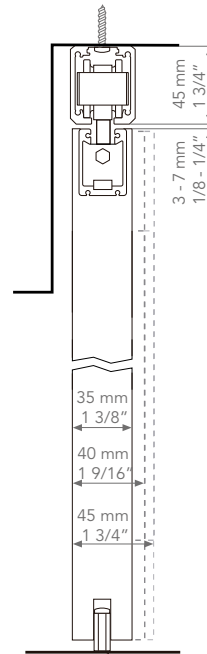

TOP

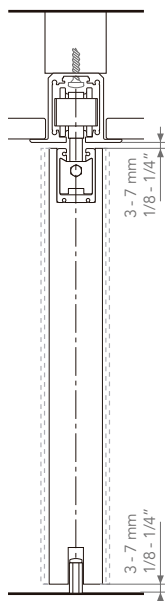

INTRA

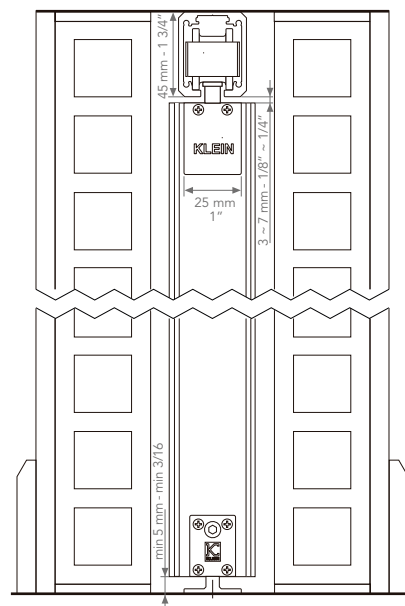

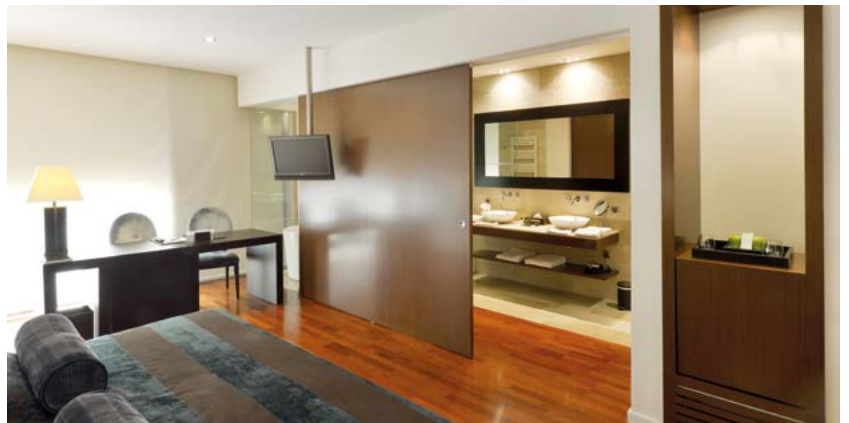



Slid Fold

Slid Fold divide espacios mediante 2, 3, 4 o 5 paneles plegables. Ofrece una máxima integración del perfil en el falso techo en su versión empotrada.

Disponible en plegado central y lateral, para cumplir con cualquier reto arquitectónico.

Slid Fold divides spaces by 2, 3, 4 or 5 folding panels. It offers maximum integration of the profile in the false ceiling in its recessed version.

Available in central and lateral folding, to meet any architectural challenge.

● Alu. Silver Mate
Alu. Silver Matte

Peso: 150 kg
Weight: 330 lbs

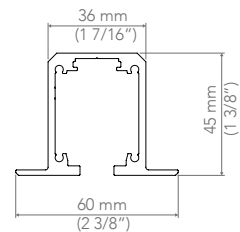
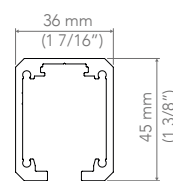



PLEGADO CENTRAL / CENTRAL FOLDING

5 HOJAS
5 PANELS

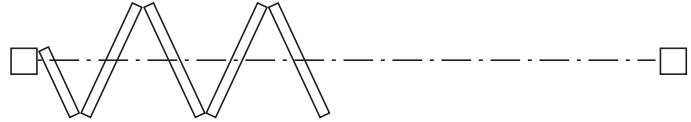

PLEGADO LATERAL / SIDE FOLDING

5 HOJAS
5 PANELS

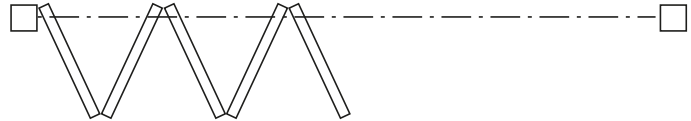

INSTALACIÓN VISTA/
EXPOSED INSTALLATION

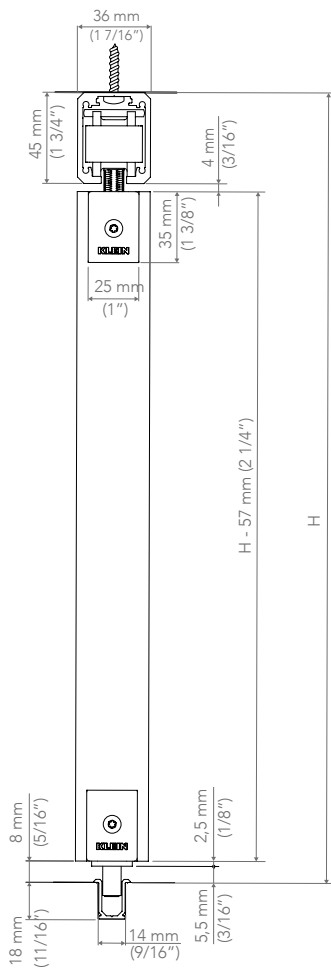

INSTALACIÓN EMPOTRADA/
RECESSED INSTALLATION

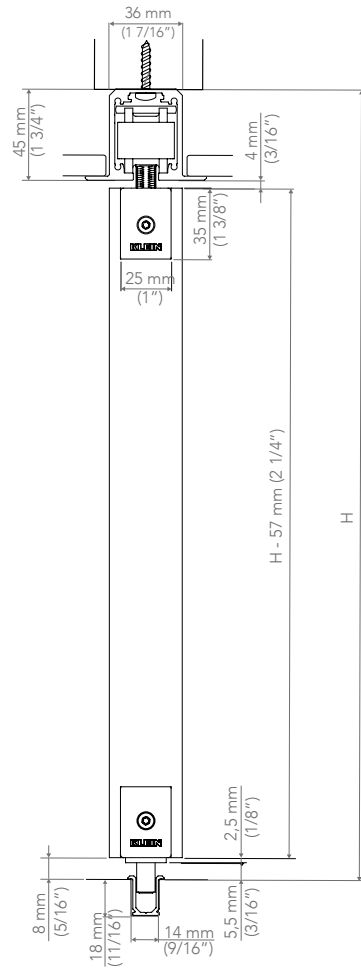





Slid Par

Slid Par abre espacios mediante 2 paneles plegables o 2+2. Es un sistema libre de perfiles en el suelo ideal para ganar flexibilidad espacial. Garantiza confort y un óptimo acceso. Su versión empotrada asegura una máxima integración del perfil en el falso techo.

Slid Par opens up spaces using 2 folding panels or 2+2. It is a profile-free system on the floor, ideal for gaining spatial flexibility. It guarantees comfort and optimum access. Its recessed version ensures maximum integration of the profile in the false ceiling.

● Alu. Silver Mate
Alu. Silver Matte

Peso: 150 kg
Weight: 330 lbs

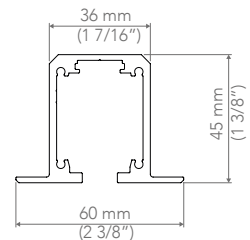
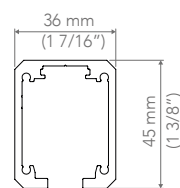



PLEGADO CENTRAL /CENTRAL FOLDING



PLEGADO LATERAL /SIDE FOLDING



INSTALACIÓN VISTA/
EXPOSED INSTALLATION

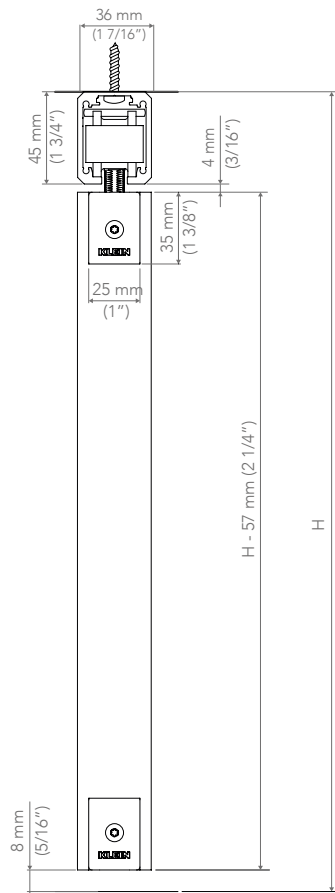

INSTALACIÓN EMPOTRADA/
RECESSED INSTALLATION

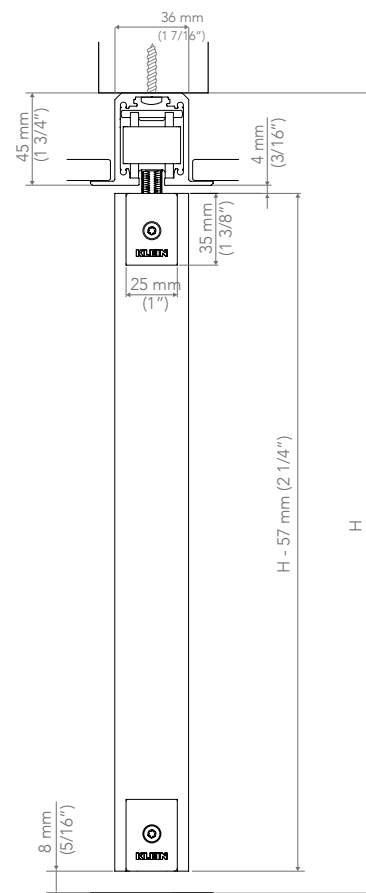





Sensus

Sensus ha sido diseñado para resistir los usos más intensivos superando el estándar de las normativas existentes, garantizando la máxima durabilidad.

Compacto y robusto; sencillo y funcional. Sensus es la síntesis de todo un ciclo de expertise, para flexibilizar espacios.

Sensus has been designed to resist even the most intensive uses, exceeding the standard for current regulations and guaranteeing maximum durability.

Compact and robust; simple and functional. Sensus is the result of a full course of expertise in making spaces more flexible.

- Alu. Silver Mate
Alu. Silver Matte
- Alu. Natural
Alu. Natural

Peso: 80 kg
Weight: 176 lbs

SENSUS 40

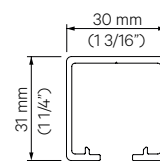

SENSUS 80

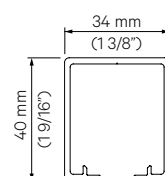



SENSUS 40

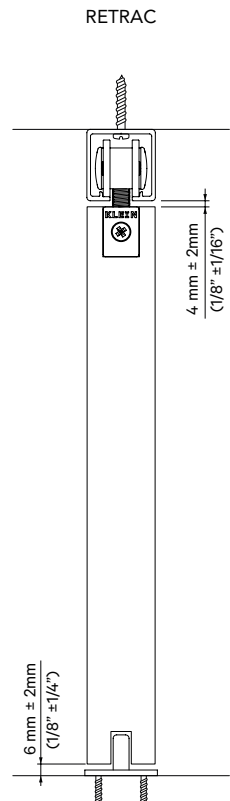
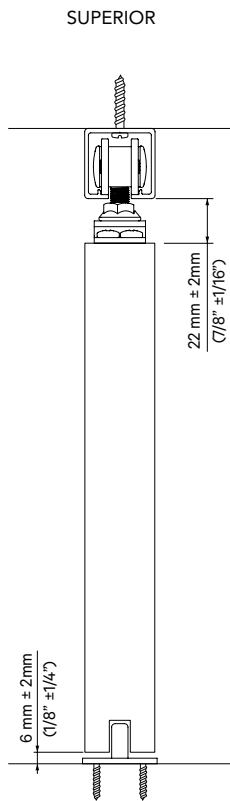

SENSUS 80

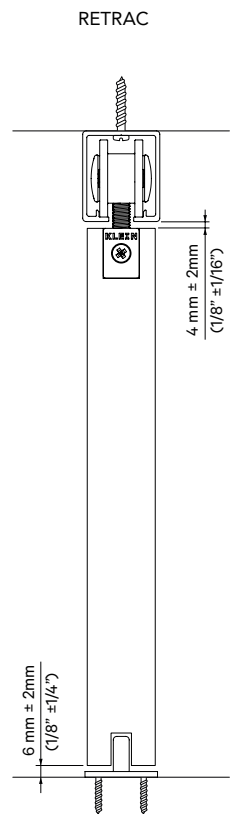
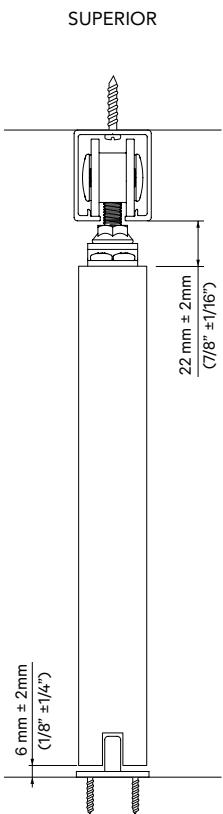

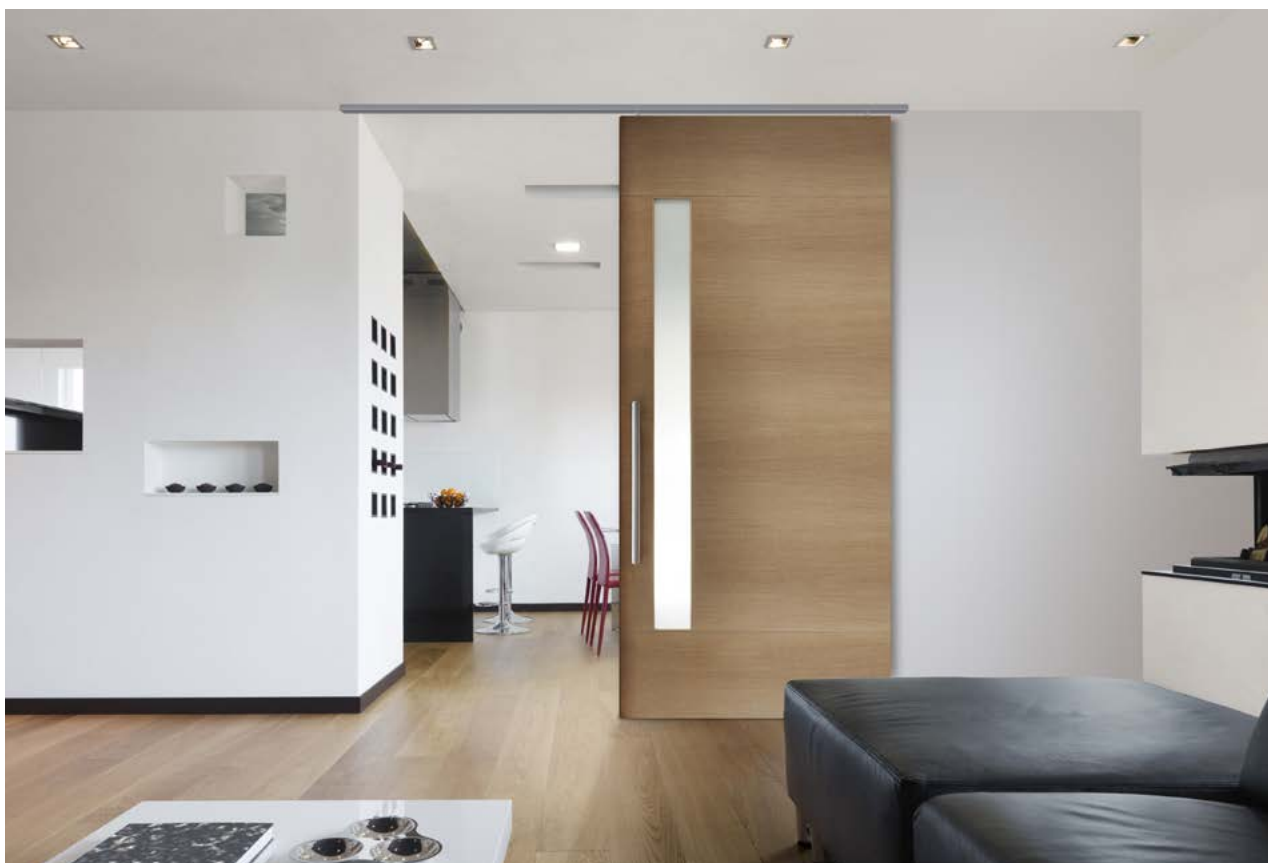



NK

NK está diseñado para guiar un panel corredero de madera o HPL. Ofrece sistema de sujeción horizontal superior o lateral, o sistema de sujeción vertical con herrajes empotrados (Retrac).

Clos NK es su versión para puertas pararelas. En todos sus versiones, requiere la instalación de un embellecedor para ocultar el mecanismo.

NK is designed to guide a wood or HPL sliding panel. It offers a side or horizontal top fastening system. It also offers a vertical fastening system with recessed fittings (Retrac).

Clos NK is the version for bi-passing doors. Regardless of the version, it requires the installation of a decorative cover to hide the mechanism.

● Alu. Natural
Alu. Natural

Peso máx./ 85 kg
Max. weight: 176 lbs

NK 60-85

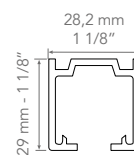

CLOS NK 60

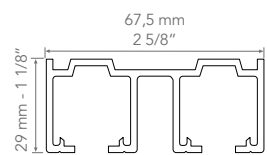

SUPERIOR

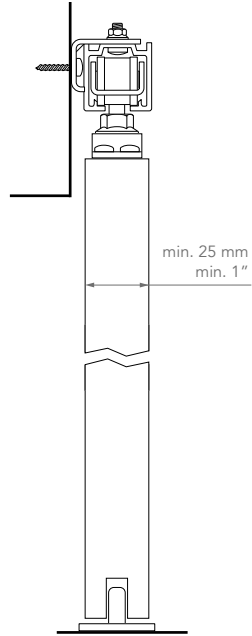

LATERAL

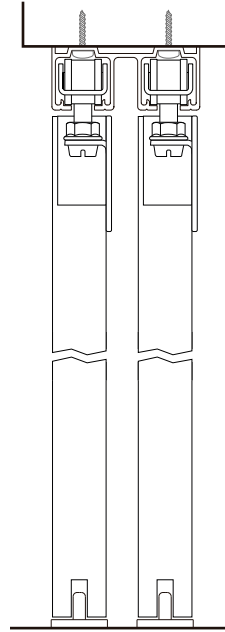

RETRAC

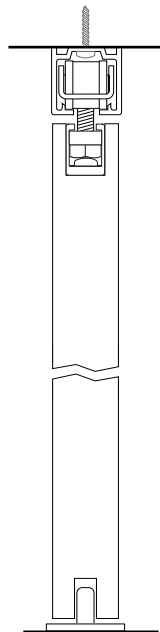

HPL

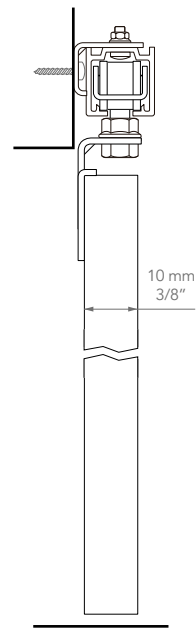



KT

KT está diseñado para conectar espacios mediante un panel corredero de grandes dimensiones, de madera o de metal. Requiere la instalación de un embellecedor para ocultar el mecanismo.

KT is designed to connect spaces with a large-scale sliding panel, made of wood or metal. It requires the installation of a decorative cover to hide the mechanism.

- Alu. Silver Mate
Alu. Silver Matte
- Acero Neocrom
Neocrom steel
- Acero Sendzimir
Sendzimir steel

Peso máx./ 200 kg
Max. weight: 441 lbs

KT 80

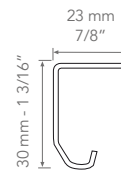

KT 200

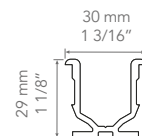
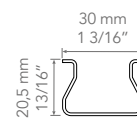
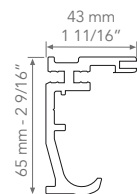



KT 80

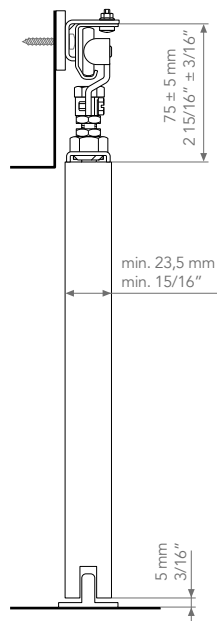

KT 200

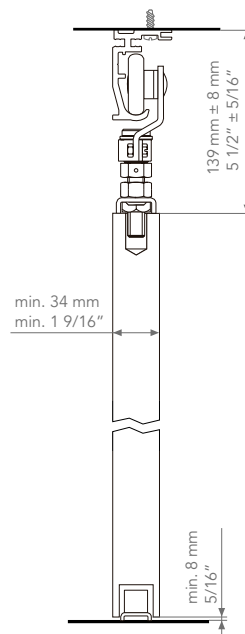



Lite Par

Lite Par abre espacios mediante dos paneles plegables, libres de perfiles en el suelo. Ahorra espacio, garantiza comodidad y un óptimo acceso. Su versión empotrada asegura una máxima integración del perfil en el falso techo.

También disponible en versión enfrentada 2+2.

Disponible en plegado central y lateral, para cumplir con cualquier reto arquitectónico.

Lite Par opens up spaces with two folding panels, without any floor profiles. It saves spaces and guarantees comfort and easy access. Its recessed version ensures maximum integration of the profile with the drop ceiling.

Also available as a 2+2 bi-parting version.

Available in central and lateral folding, to meet any architectural challenge.

● Alu. Silver Mate
Alu. Silver Matte

Peso total hojas/ Total weight panels:	100 kg 220 lbs
---	-------------------

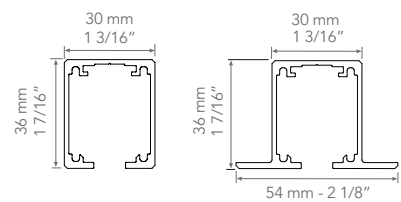

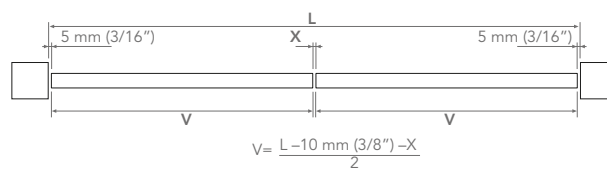
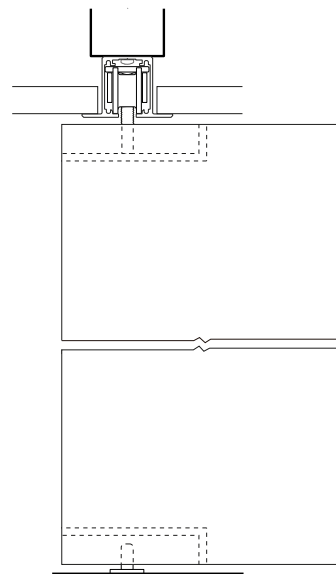
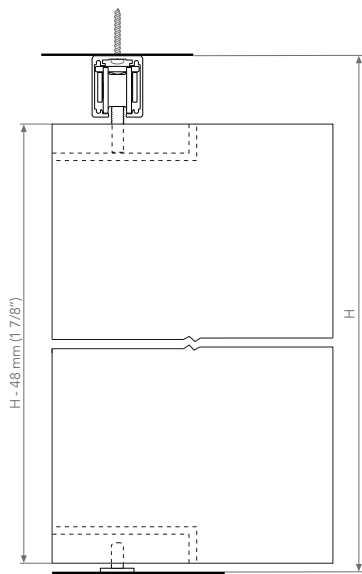



Lite Fold

Lite Fold abre espacios mediante un sistema de 2, 3, 4 o 5 paneles plegables. Ahorra espacio y requiere un aparcamiento reducido. Perfil Top empotrable para instalaciones invisibles.

Compatible con bisagras invisibles estándares.

Disponible en plegado central y lateral, para cumplir con cualquier reto arquitectónico.

Lite Fold opens up spaces with a system of 2, 3, 4 or 5 folding panels. It saves spaces and requires very little space for storing open doors. Recessed Top profile for invisible installations.

Compatible with standard invisible hinges.

Available in central and lateral folding, to meet any architectural challenge.

- Alu. Silver Mate
- Alu. Silver Matte

Peso total hojas/ Total weight panels:	100 kg 220 lbs
---	-------------------

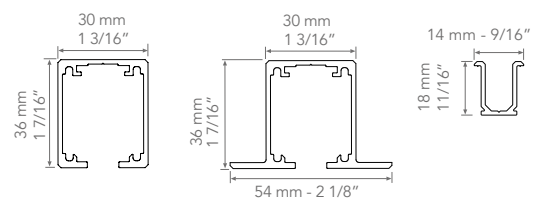

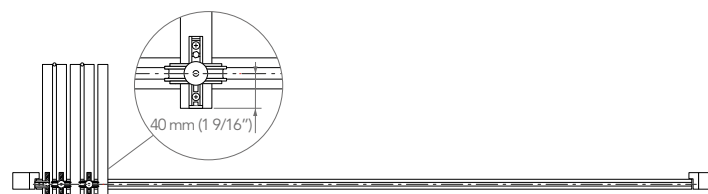
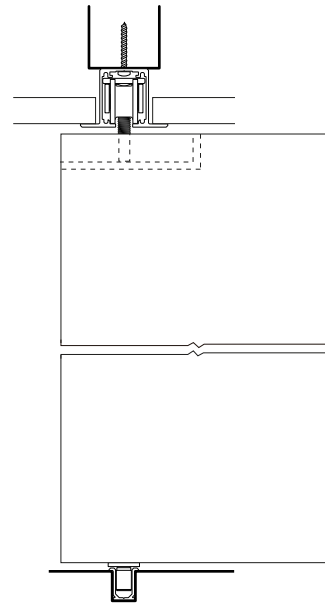
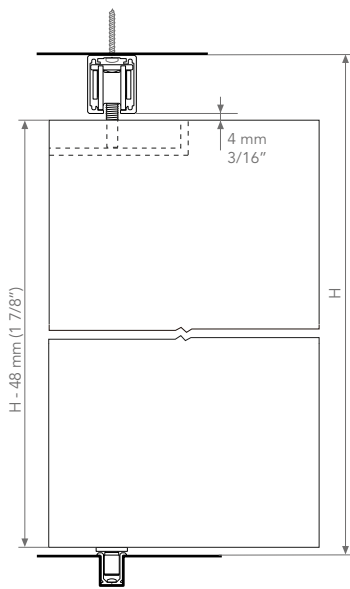



FRONT | Mario Franco Denis



Architectural Interior Systems



NK Fold

NK Fold es un sistema de apertura de hasta 5 paneles plegables de madera.

Tres opciones de plegado: guiado central, lateral enrasado y lateral solapado.

NK Fold is a system for opening up to 5 folding wood panels.

Three folding options: central guide, flush side guide and overlapping side guide.

- Alu. Silver Mate
Alu. Silver Matte
- Alu. Natural
Alu. Natural

Peso Par de Hojas/ 40 kg
Two panels Weight: 88 lbs

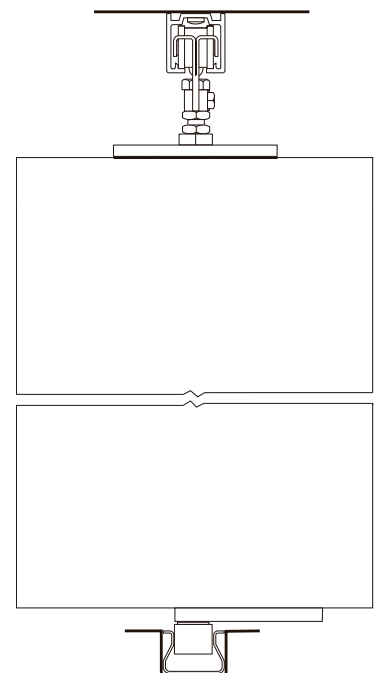
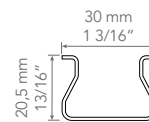
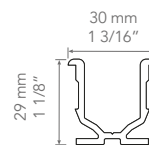
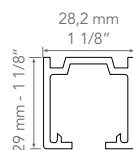



NK Par

NK Par es un sistema para puertas plegables de dos paneles enrasados a pared. Disponible en versión de puertas enfrentadas 2+2.

NK Par is a system for two-panel folding doors that are flush with the wall. It is also available as a 2+2 bi-parting doors version.

- Alu. Silver Mate
Alu. Silver Matte
- Alu. Natural
Alu. Natural

Peso Par de Hojas/ Two panels Weight:	40 kg 88 lbs
--	-----------------

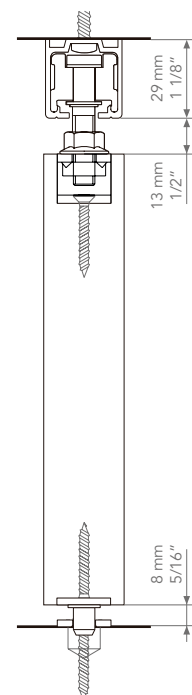
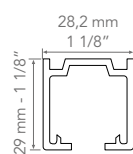



KP

KP es un sistema de apertura de hasta 5 paneles plegables de madera o de metal.

Tres opciones de plegado: guiado central, guiado lateral enrasado, guiado lateral con hojas solapadas.

KP is a system for opening up to 5 folding wood or metal panels.

Three folding options: central guide, flush side guide and overlapping panel side guide.

● Alu. Silver Mariner
Alu. Silver Mariner

Peso Par de Hojas/ Two panels Weight:	100 kg 220 lbs
--	-------------------

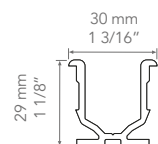
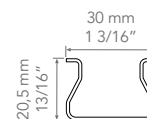
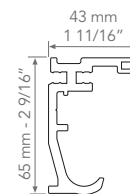



KP 100 C

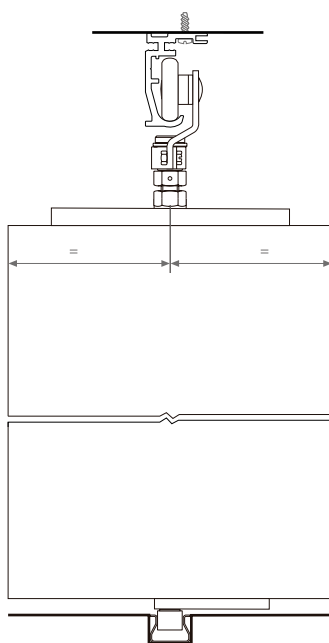

KP 100 S

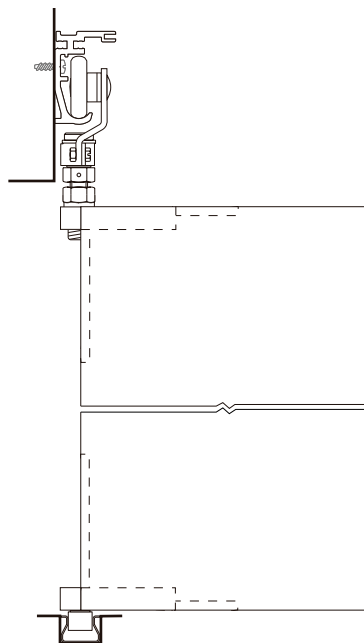

KP 100 E

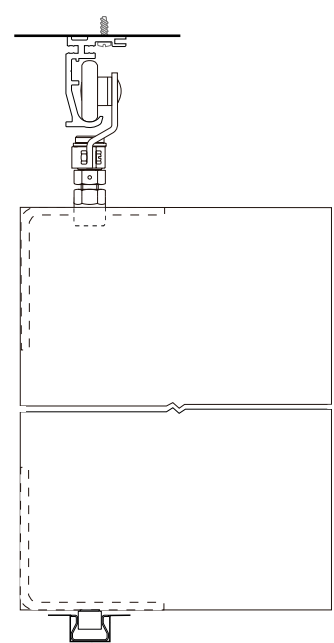



Stockpanel

Stockpanel está diseñado para abrir espacios mediante paneles de madera correderos, que se apilan perpendicular o paralelamente. Es ideal para dividir salas de restaurantes o salas de conferencias. Configuración con una o dos zonas de aparcamiento.

Aprovechamiento óptimo de la luz de paso.

Stockpanel is designed to open up spaces with sliding wood panels that are stacked in either a perpendicular or parallel configuration. It is ideal for dividing restaurant dining rooms or conference rooms. Configuration with one or two areas for storing open doors.

Optimal use of passageway.

● Alu. Silver Mate
Alu. Silver Matte

Peso máx./ 150 kg
Max. weight: 330 lbs

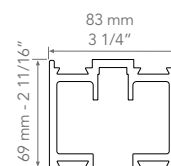

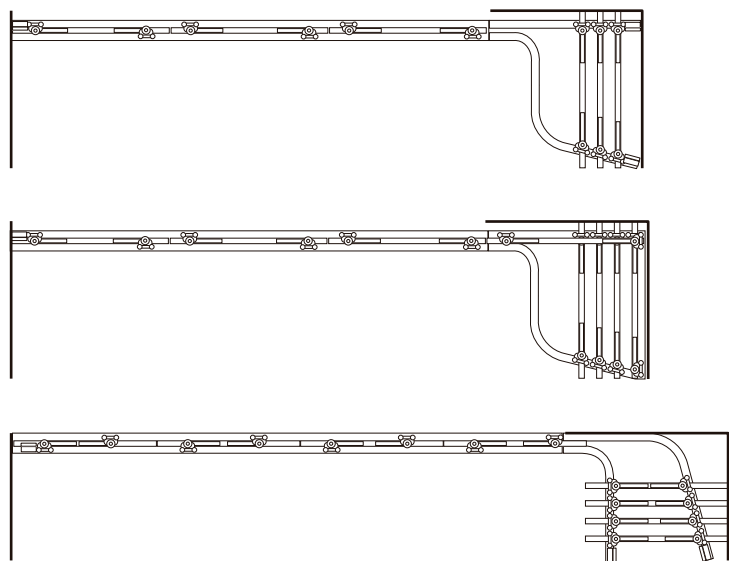
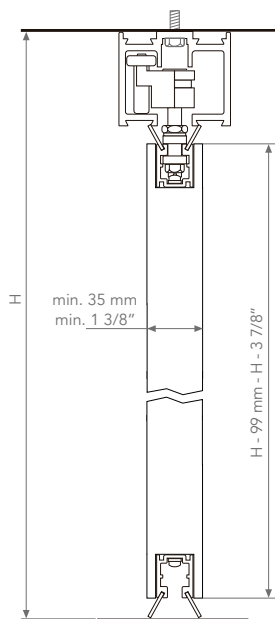









DISEÑO **INDUSTRIAL**

Industrial Design

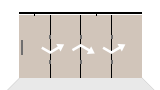
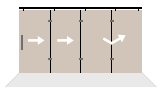

K | Miriam Barrio - Interiorismo

APLICACIÓN/ APPLICATION	PRODUCTO/ PRODUCT	PÁG./ PAGE	PESO*/ WEIGHT*		FRENO BRAKE			INSTALACIÓN MOUNTING		
			≤100	>100	KBS	KSC	SELF	PARED WALL	TECHO CEILING	EMPOTRABLE RECESSED
PUERTAS CORREDERAS ÚNICA/ SINGLE SLIDING DOORS 	K	166	●	●				●	●	
PUERTAS PLEGABLES/ FOLDING DOORS 	PL	168	●	●				●	●	
PUERTAS ARTICULADAS/ ARTICULATED DOORS 	AR	170	●	●				●	●	

* Su peso se calcula en base a la siguiente fórmula: Altura [m] x Ancho [m] x Espesor [mm] x Densidad = Peso [kg]

* The weight is calculated based on the following formula: Height [m] x Width [m] x Thickness [mm] x Density = Weight [kg]

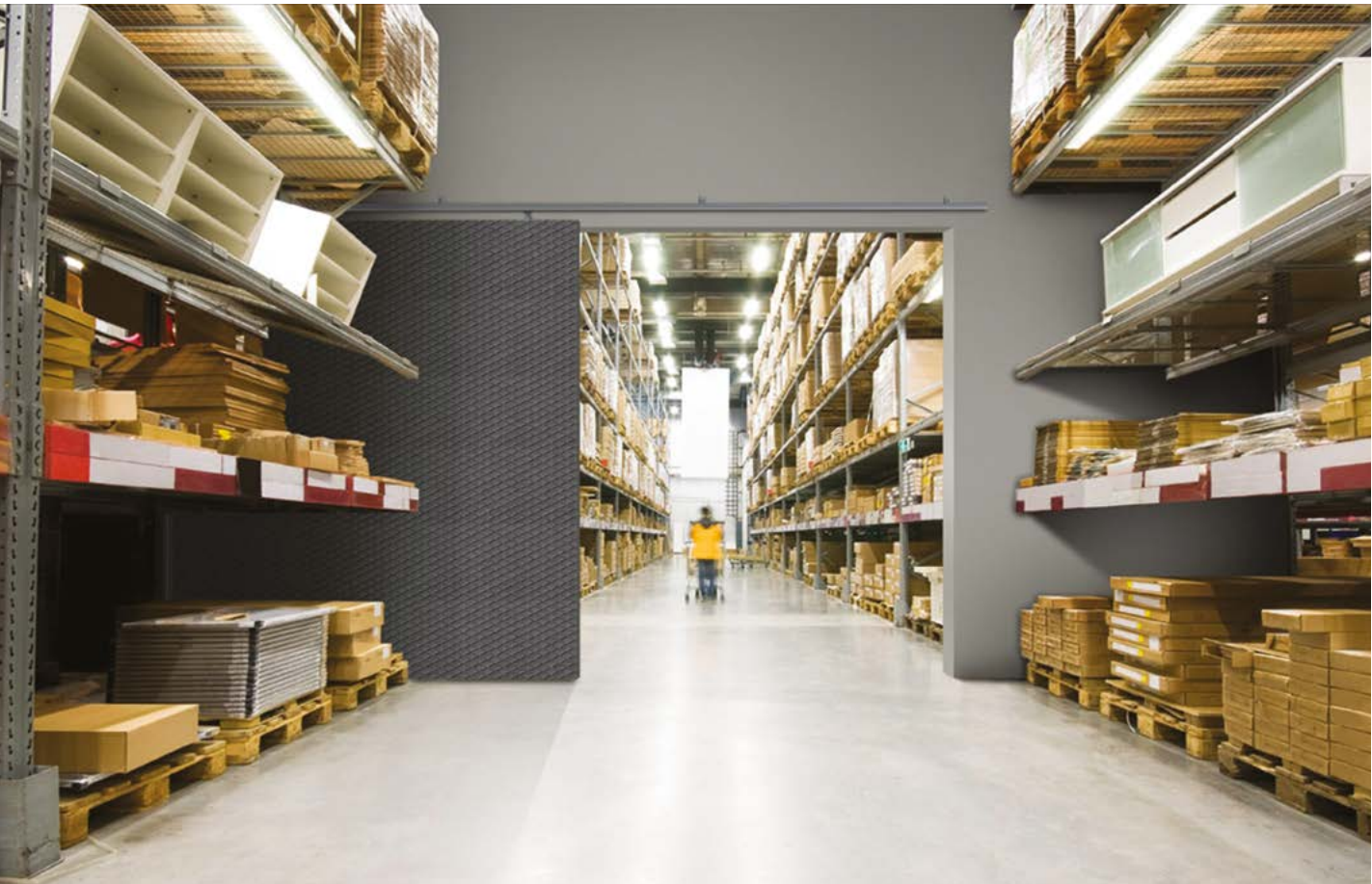

K

K es el sistema ideal para espacios industriales. Está diseñado para dividir ambientes mediante un único panel de grandes dimensiones, de madera o de metal.

K is the ideal system for industrial spaces. It is designed to divide spaces with a single large-scale panel, made of wood or metal.

- Acero Neocrom
Neocrom Steel
- Acero Sendzimir
Sendzimir steel

Peso máx./ 500 kg
Max. weight: 1102 lbs

K 40/75

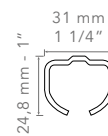

K 150/300

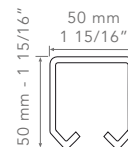

K 500

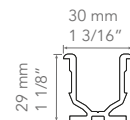
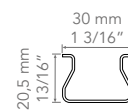
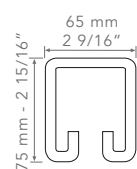



K 40/75

K 150/300

K 500

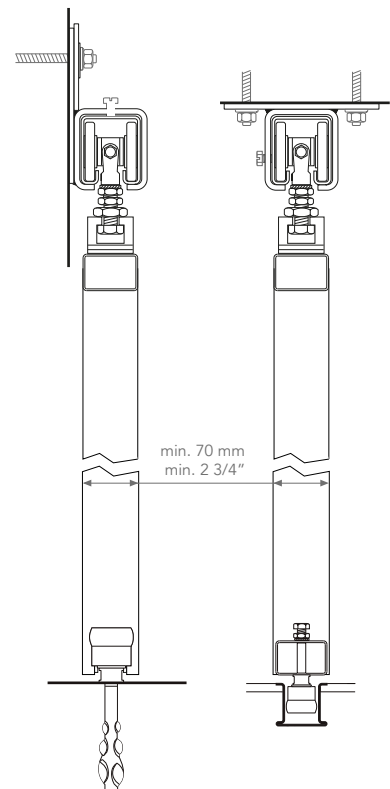
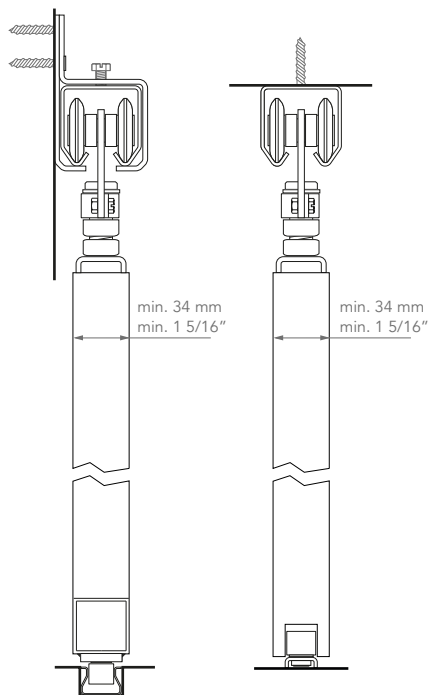
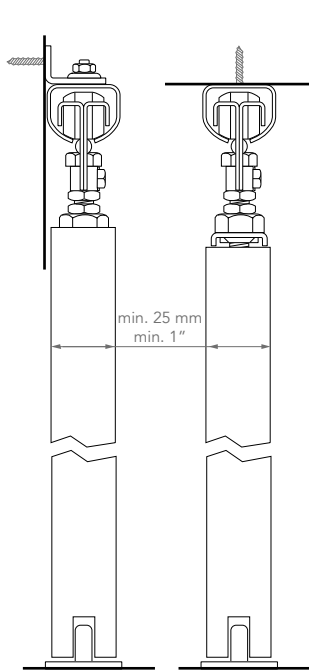



PL

PL es un sistema de apertura de hasta 5 paneles plegables de madera o de metal.

Tres opciones de plegado: guiado central, lateral enrasado y lateral solapado.

PL is a system for opening up to 5 folding wood or metal panels.

Three folding options: central guide, flush side guide and overlapping side guide.

- Acero Neocrom
Neocrom Steel
- Acero Sendzimir
Sendzimir steel

Peso Par de Hojas/ 150 kg
Two panels Weight: 330 lbs

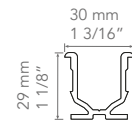
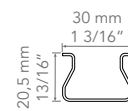
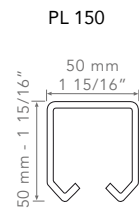
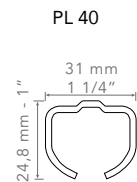

PL 40 C

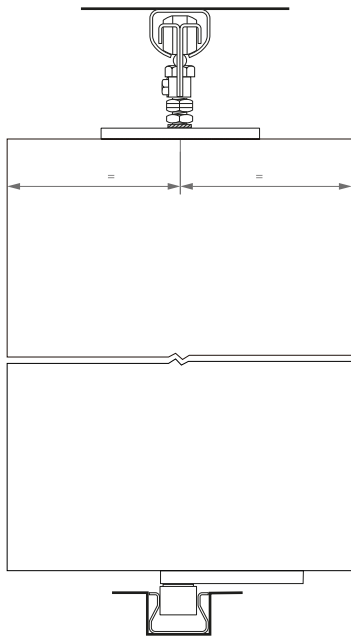

PL 40 S

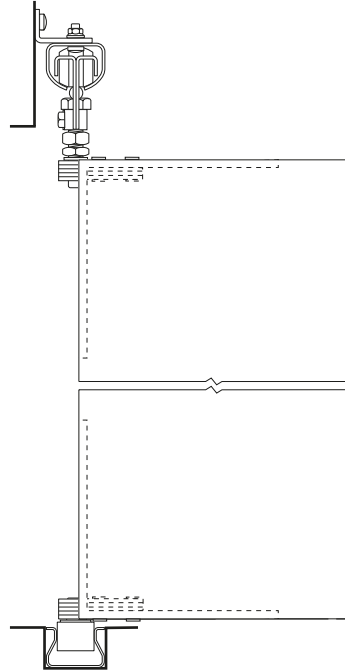

PL 150 C

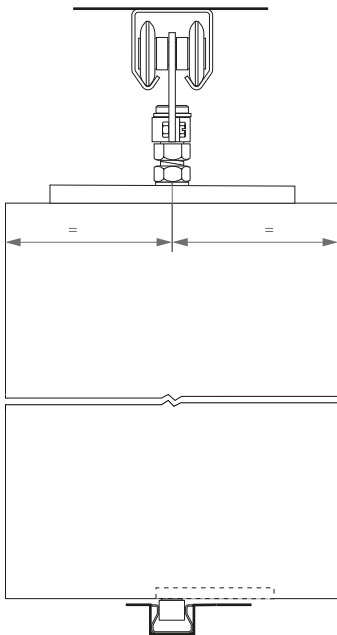

PL 150 E

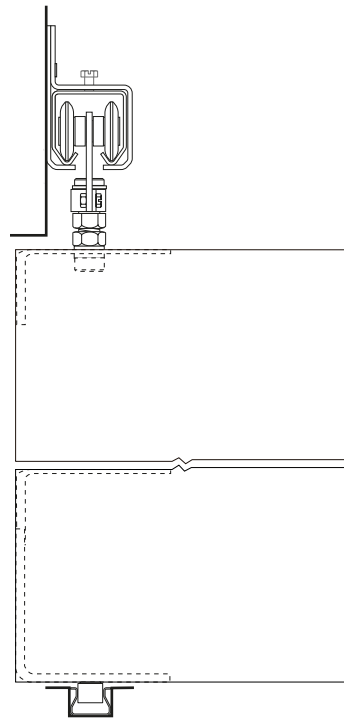



AR

AR está diseñado para abrir espacios mediante un sistema de paneles articulados de madera o de metal. Admite un máximo de 5 hojas por sistema.

AR is designed to open up spaces with a system of hinged wood or metal panels. It supports up to 5 panels per system.

● Acero Neocrom
Neocrom Steel

Peso máx./ 125 kg
Max. weight: 276 lbs

AR 35

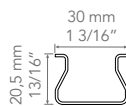
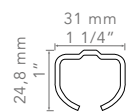

AR 125

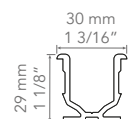
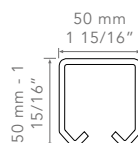

AR 35

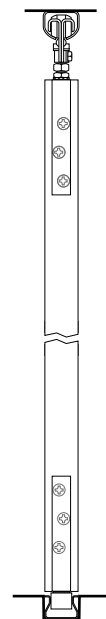

AR 125

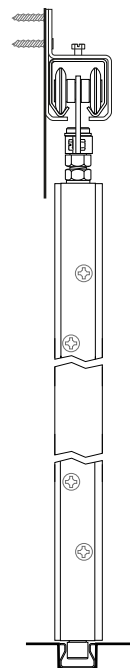

Architectural Interior Systems









MUEBLES Y **ARMARIOS**

Furniture and wardrobes



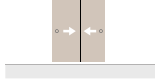
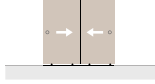

ROLL | Muebles y armarios - Furniture and wardrobes

APLICACIÓN/ APPLICATION	PRODUCTO/ PRODUCT	PÁG./ PAGE	PESO*/ WEIGHT*		FRENO BRAKE			INSTALACIÓN MOUNTING		
			≤100	>100	KBS	KSC	SELF	PARED WALL	TECHO CEILING	EMPOTRABLE RECESSED
PUERTAS PARALELAS/ BI PASSING DOORS		K	178	●					●	
		ROLL	180	●					●	
PUERTAS PLEGABLES/ FOLDING DOORS		NK PAR	184	●					●	

* Su peso se calcula en base a la siguiente fórmula: Altura [m] x Ancho [m] x Espesor [mm] x Densidad = Peso [kg]

* The weight is calculated based on the following formula: Height [m] x Width [m] x Thickness [mm] x Density = Weight [kg]



K

K está diseñado para la apertura de muebles y armarios mediante uno o varios paneles correderos paralelos de madera, con el fin de conseguir varios accesos dentro de la misma aplicación.

K is designed for opening furniture and wardrobes with one or several bi-passing sliding wood panels, thus allowing for several access points in a single application.

- Alu. Natural
Alu. Natural
- Acero Neocrom
Neocrom Steel
- Acero Sendzimir
Sendzimir steel

Peso máx./ 30 kg
Max. weight: 66 lbs

K 20/30

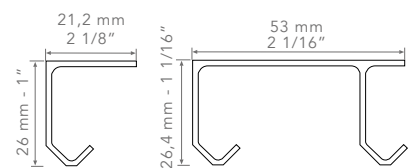

K 20/30

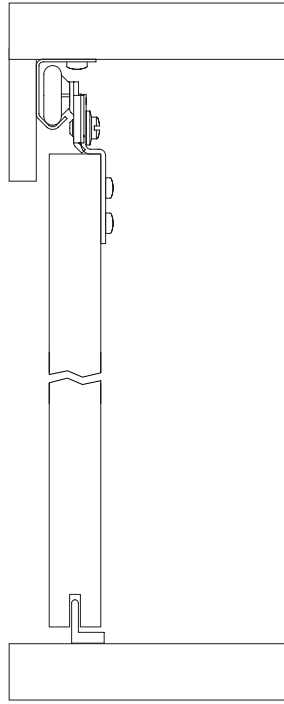

K 20/30
PERFIL DOBLE / DOUBLE TRACK

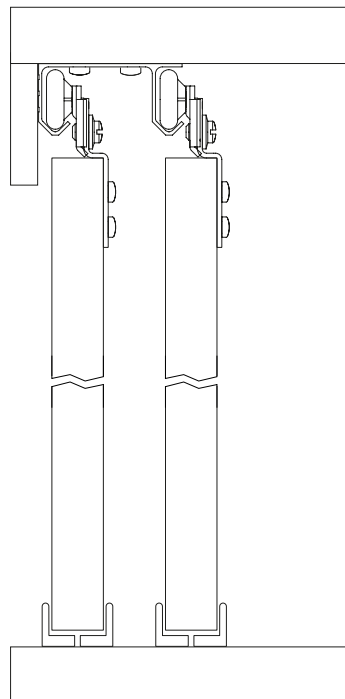
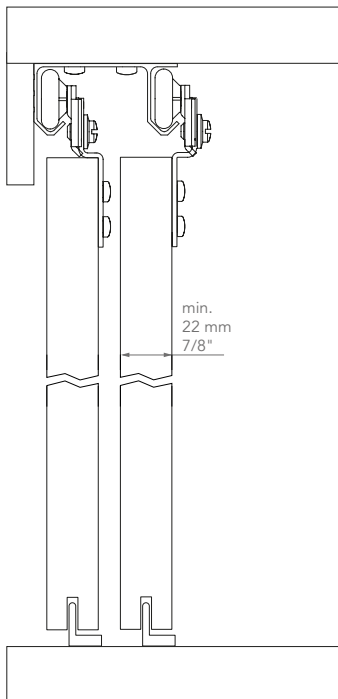



Roll

Roll está diseñado para la apertura de muebles y armarios mediante dos paneles paralelos de madera. Garantiza un mínimo espacio entre puerta y marco.

Roll is designed for opening furniture and wardrobes with two bi-passing wood panels. It guarantees a minimal gap between the door and frame.

- Alu. Natural
Alu. Natural
- Alu. Silver
Alu. Silver
- Alu. Negro
Alu. Black
- Alu. Brass
Alu. Brass

- PVC Marron
Brown PVC
- PVC Blanco
White PVC
- PVC Negro
Black PVC

Peso máx./ 52 kg
Max. weight: 115 lbs

ROLL 25

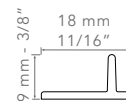

ROLL 42

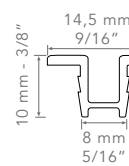

ROLL 52

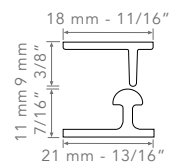



ROLL 42

ROLL 45

ROLL 52

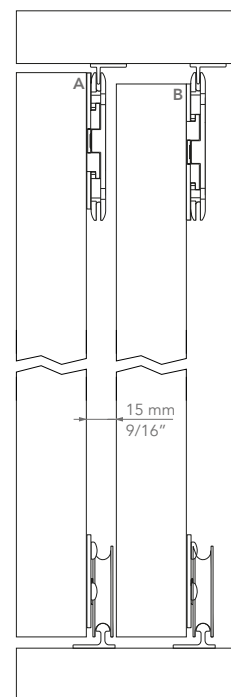
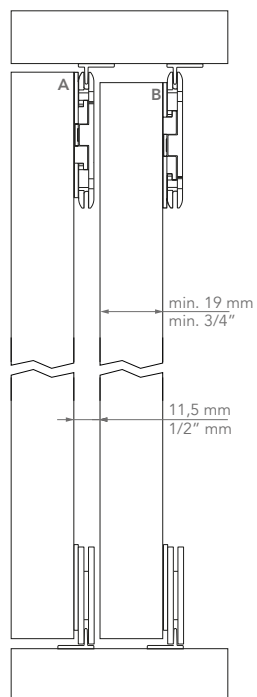
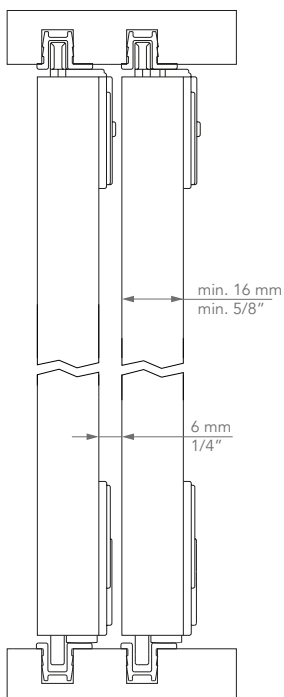





NATURE | Francesc Rifé Studio



NK Par

NK Par es un sistema para armarios, de dos paneles plegables. Existe en versión para puertas enrasadas o puertas sobrepuestas.

NK Par is a system for wardrobes, with two folding panels. There is a version for flush doors and another for superimposed doors.

● Alu. Natural
Alu. Natural

Peso máx./ 25 kg
Max. weight: 55 lbs

NK PAR 15/25

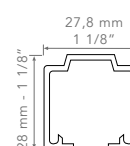

NK PAR 15

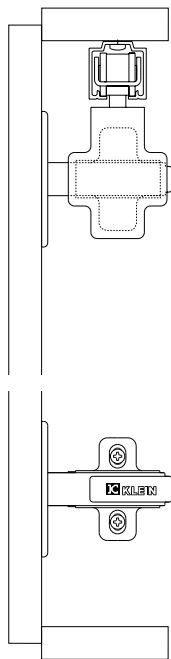

NK PAR 25

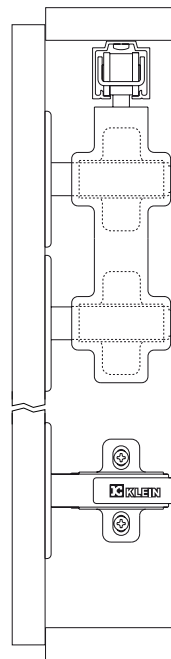



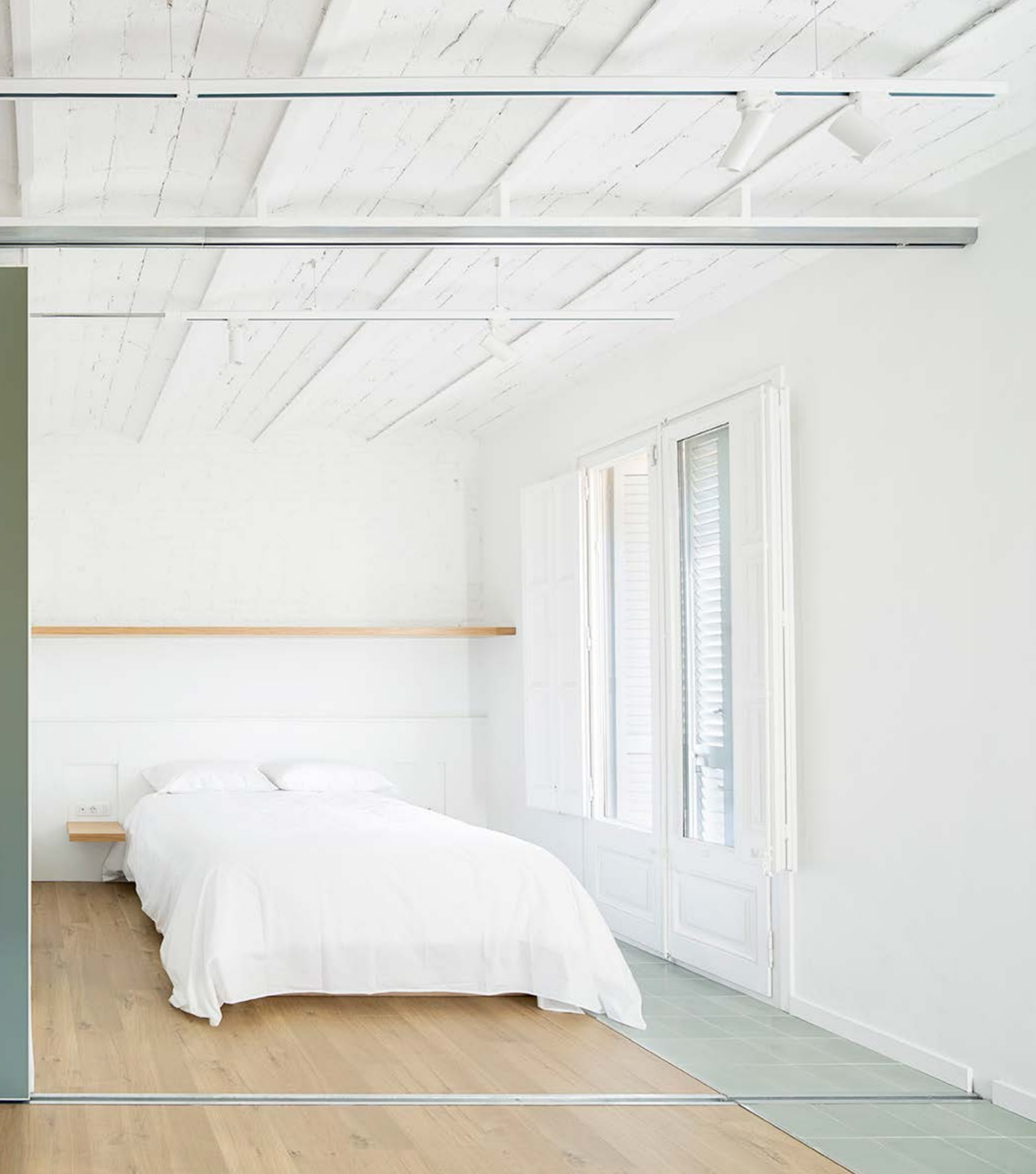

Nueva tienda online para profesionales de la construcción.

New online shop for construction professionals

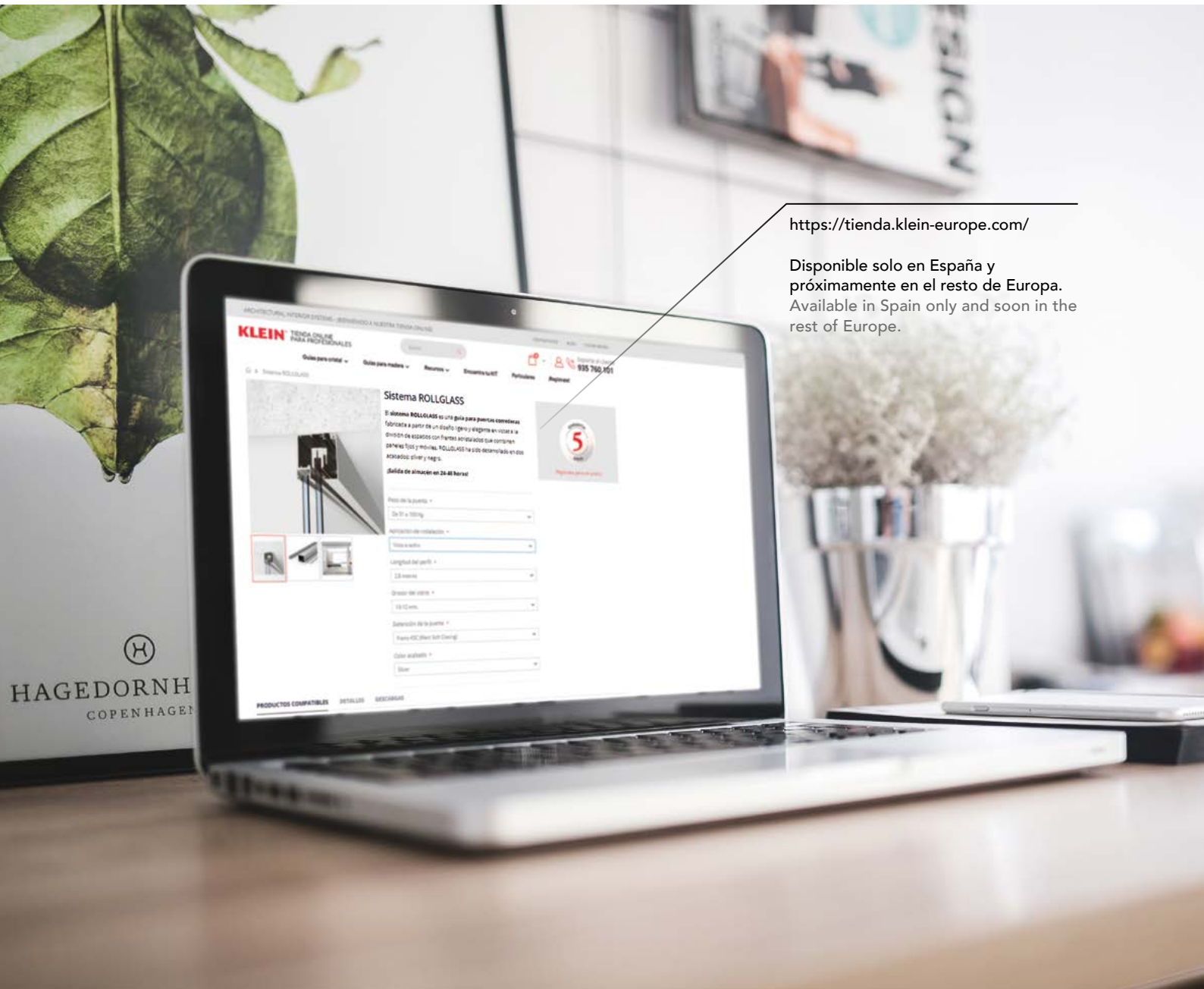

<https://tienda.klein-europe.com/>

Disponible solo en España y próximamente en el resto de Europa.
Available in Spain only and soon in the rest of Europe.

¿Tiene un proyecto?

Are you developing a project?

No dude en contactarnos. ¡Te asesoramos desde el nacimiento de tu idea hasta su realización!

Para más información, consulte nuestra página web:
www.klein-europe.com

Suscríbese a nuestra Newsletter, le mantendremos informado de las últimas tendencias y novedades.

Feel free to get in touch with us. We are here to help from the very start of your idea until its completion!

For more information, go to our website:
www.klein-europe.com

Sign up for our Newsletter so that we can keep you up-to-date on the latest trends and news.

Síguenos en Redes Sociales.

We are also on Social Media. Follow us!





ELEMENTAL
CHLORINE
FREE
GUARANTEED



ACID FREE



KLEIN[®]

KLEIN EUROPE
Polígono Industrial Can Cuyás
N-150 Km. 1
08110 Montcada i Reixac
Barcelona (Spain)

Tel.: +34 935 760 101
Fax: +34 935 760 109

+Info
klein@klein.es
www.klein.es

Síguenos en redes
Follow us on social media

