

KLEIN

Sliding doors with soft closing system



ROLLGLASS+

Interior Design Glass
Interiorismo vidrio



reddot award 2018
winner



ROLLGLASS+

SILVER



BRONZE



BLACK



KBS



KSC

ENG

Rollglass+: creates a glass front that combines fixed and mobile glass panels on a single track. It can be hidden in a drop ceiling for a completely minimalist effect. Versatile and flexible, it allows for various combinations, down to the smallest detail.

- Installation on ceiling or in drop ceiling.
- Special profile with hidden dropped ceiling wings for maximum architectural integration.
- A new clamp which centralises all features of the system: height adjustment, activation of the braking mechanism, and anti-derailing device.
- Fast and intuitive assembly for efficient implementation:
 - Direct access to the clamp.
 - System embedded in drop ceiling: two-phase assembly for easy installation.
 - Bottom profile in a double "L" shape for easy frontal insertion of the glass.
- Clean, innovative design.
- Available with or without bottom profile for the fixed glass.
- 3/8" or 1/2" glass, weighing up to 550 lbs per sliding panel.
- Height adjustment of +/- 1/8".
- Silver, Black and Bronze anodized aluminum profiles.
- Silent and effortless sliding.
- Cradle To Cradle certified product for Rollglass+ 50 and 100.
- Five-year KLEIN® warranty.
- Soft closing options:
 - **KSC, Klein Soft Closing:** Smooth, controlled closing.
 - **KBS, Klein Brake System:** Stop with damper brake. Standard for the entire line.

Systems tested up to 100,000 cycles as per standard EN1527 by

ESP

Rollglass+: crea un frente acristalado que combina paneles de vidrio fijos y móviles mediante una única guía. Puede esconderse en falso techo para un efecto absolutamente minimalista. Versátil y flexible, permite variadas combinaciones y cuida todos los detalles.

- Instalación a techo o a falso techo.
- Perfil especial para falso techo, con aletas escondidas para una máxima integración arquitectónica.
- Nueva mordaza: centraliza todas las prestaciones del sistema: regulación en altura, activación del mecanismo de frenado, y dispositivo antidescabalgamiento.
- Montaje rápido e intuitivo:
 - Acceso directo a la mordaza.
 - Sistema empotrado a falso techo: montaje en dos fases para una instalación eficiente.
 - Perfil inferior en "L" para una fácil inserción frontal del vidrio.
- Diseño limpio e innovador.
- Disponible con o sin perfil inferior para el vidrio fijo.
- Vidrio de 3/8" o 1/2", hasta 550 lbs por hoja corredera.
- Regulación de la altura de +/- 1/8".
- Perfil de aluminio anodizado Silver, Negro y Bronce.
- Deslizamiento silencioso y con mínimo esfuerzo.
- Producto certificado con Cradle To Cradle para Rollglass+ 50 y 100.
- Garantía KLEIN® 5 años.
- Opciones de frenado de la puerta:
 - **KSC, Klein Soft Closing:** Detención suave controlada.
 - **KBS, Klein Brake System:** Tope con freno amortiguador. De serie en toda la gama.*

Systemas testados hasta 100.000 ciclos según la norma EN1527 por IFT Rosenheim.

ROLLGLASS+ 50

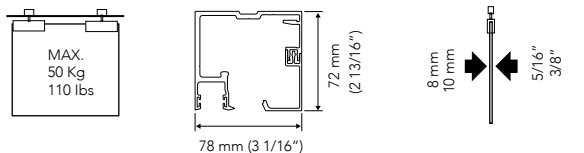

ROLLGLASS+ 100

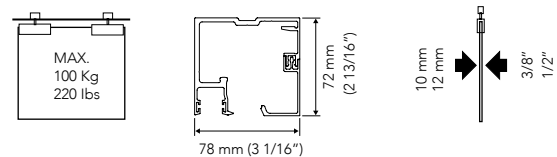

ROLLGLASS+ 150

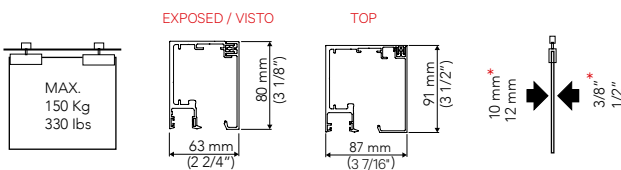

ROLLGLASS+ 250

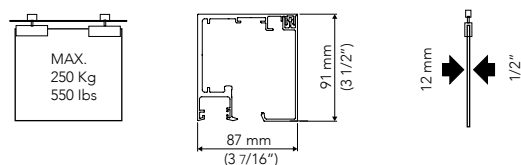

3/8" - Just compatible with Rollglass+ 150 exposed / 3/8" - Solo compatible con Rollglass+ 150 visto

Exposed / Visto



$Y1 = H1 - 57 \text{ mm (2 1/4")}$

$Z1 = H1 - 89 \text{ mm (3 1/2")}$

ROLLGLASS+ 250

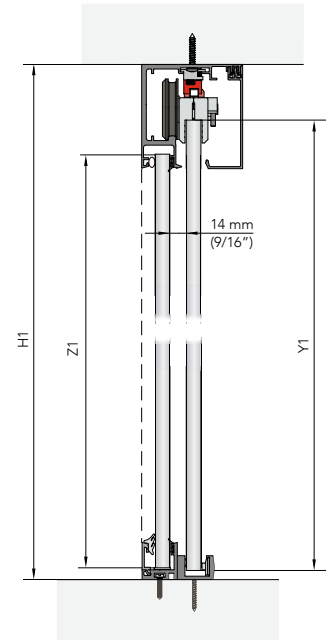

ROLLGLASS+ 100

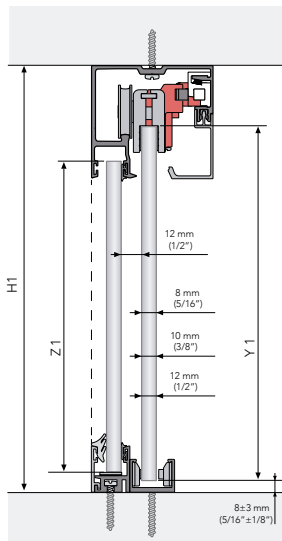

$Y1 = H1 - 47 \text{ mm (1 13/16")}$

$Z1 = H1 - 74 \text{ mm (2 7/8")}$

$Z = H - 79 \text{ mm (3 1/8")}$

$Y1 = H - 54 \text{ mm (2 1/8")}$

ROLLGLASS+ 150

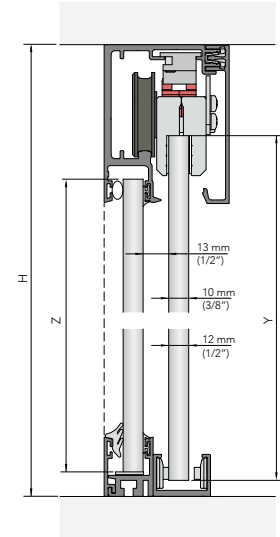

(VIDRIO FIJO / FIXED GLASS)

(VIDRIO FIJO / FIXED GLASS)

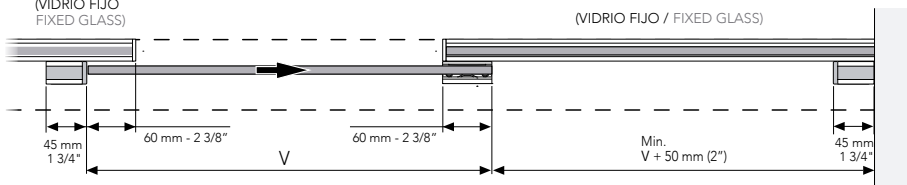

KSC ROLLGLASS+ 50/100 $V \geq 800 \text{ mm (31 1/2")}$

KSC ROLLGLASS+ 150 $V \geq 1.000 \text{ mm (39")}$

KSC ROLLGLASS+ 250 $V \geq 1.500 \text{ mm (60")}$



Recessed / Empotrado

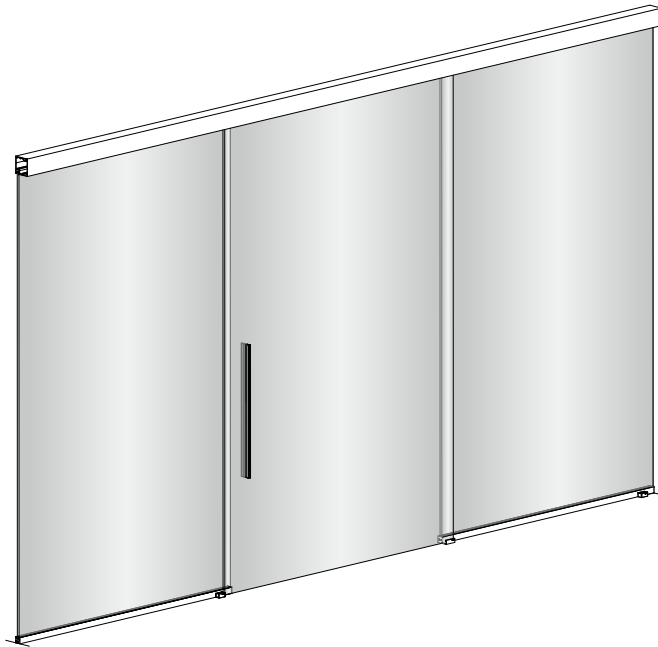

ROLLGLASS+ 250

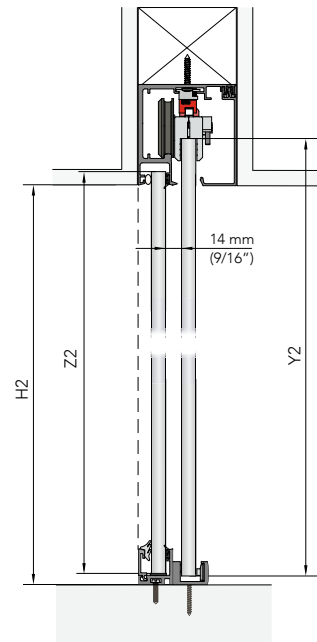

$Y2 = H2 + 34 \text{ mm (1 11/32")}$

$Z2 = H2$

ROLLGLASS+ 100

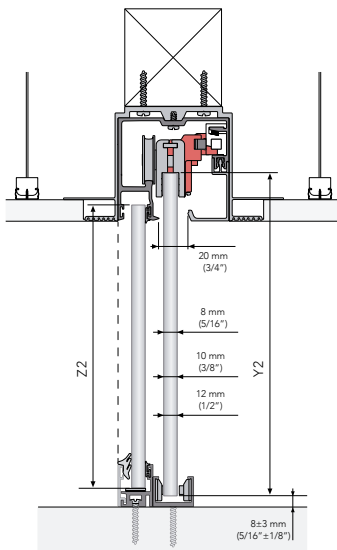

Y2 / Z2
See our mounting instructions /
Ver nuestra hoja de instrucciones

ROLLGLASS+ 150 TOP

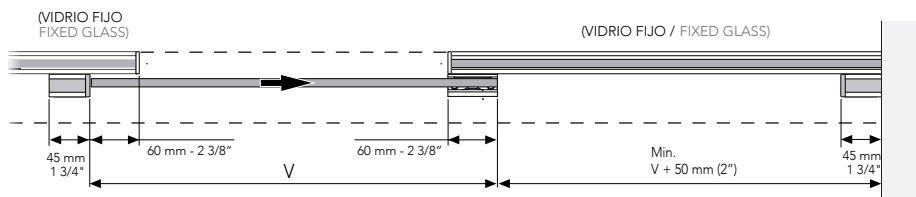
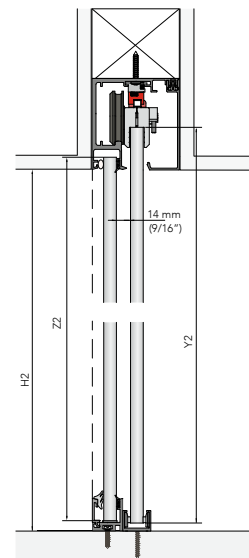

- KSC** ROLLGLASS+ 50/100 $V \geq 800 \text{ mm (31 1/2")}$
- KSC** ROLLGLASS+ 150 $V \geq 1.100 \text{ mm (43")}$
- KSC** ROLLGLASS+ 250 $V \geq 1.500 \text{ mm (60")}$



REFERENCES / REFERENCIAS

ENG

ROLLGLASS+ 100 SILVER			
Ref.	Description	Units	Img.
8453	KIT RG+ 100 KSC 118" TRACKS	1	A+E
8454	KIT RG+ 100 KSC 157" TRACKS	1	A+E
8463	KIT RG+ 100 KBS 118" TRACKS	1	A+F
8464	KIT RG+ 100 KBS 157" TRACKS	1	A+F
2493	RECESSED TRACK RG+ 118"	1	B
2494	RECESSED TRACK RG+ 157"	1	B
8400	SET OF ACC. RG+ 100 KSC	1	E
8450	SET OF ACC. RG+ 100 KBS	1	F

ROLLGLASS+ 100 BRONZE			
Ref.	Description	Units	Img.
8455	KIT RG+ 100 KSC 118" TRACKS	1	C+G
8456	KIT RG+ 100 KSC 157" TRACKS	1	C+G
8465	KIT RG+ 100 KBS 118" TRACKS	1	C+H
8466	KIT RG+ 100 KBS 157" TRACKS	1	C+H
8401	SET OF ACC. RG+ 100 KSC	1	G
8451	SET OF ACC. RG+ 100 KBS	1	H

ROLLGLASS+ 100 BLACK			
Ref.	Description	Units	Img.
8457	KIT RG+ 100 KSC 118" TRACKS	1	D+I
8458	KIT RG+ 100 KSC 157" TRACKS	1	D+I
8467	KIT RG+ 100 KBS 118" TRACKS	1	D+J
8468	KIT RG+ 100 KBS 157" TRACKS	1	D+J
8402	SET OF ACC. RG+ 100 KSC	1	I
8452	SET OF ACC. RG+ 100 KBS	1	J

ROLLGLASS+ 150 SILVER			
Ref.	Description	Units	Img.
2549	KIT ROLLGLASS+ 150 SILVER V12 (118")	1	K
2548	KIT ROLLGLASS+ 150 SILVER V12 (157")	1	K
2541	KIT ROLLGLASS+ 150 SILVER V10 (118")	1	K
2542	KIT ROLLGLASS+ 150 SILVER V10 (157")	1	K

ROLLGLASS+ 150 BLACK			
Ref.	Description	Units	Img.
2565	KIT ROLLGLASS+ 150 BLACK V12 (118")	1	L
2568	KIT ROLLGLASS+ 150 BLACK V12 (157")	1	L
2560	KIT ROLLGLASS+ 150 BLACK V10 (118")	1	L
2561	KIT ROLLGLASS+ 150 BLACK V10 (157")	1	L

ESP

ROLLGLASS+ 100 SILVER			
Ref.	Descripción	U.	Img.
8453	KIT RG+ 100 KSC PERFIL 118"	1	A+E
8454	KIT RG+ 100 KSC PERFIL 157"	1	A+E
8463	KIT RG+ 100 KBS PERFIL 118"	1	A+F
8464	KIT RG+ 100 KBS PERFIL 157"	1	A+F
2493	PERFIL FALSO TECHO RG+ 118"	1	B
2494	PERFIL FALSO TECHO RG+ 157"	1	B
8400	JGO. ACC. RG+ 100 KSC	1	E
8450	JGO. ACC. RG+ 100 KBS	1	F

ROLLGLASS+ 100 BRONCE			
Ref.	Descripción	U.	Img.
8455	KIT RG+ 100 KSC PERFIL 118"	1	C+G
8456	KIT RG+ 100 KSC PERFIL 157"	1	C+G
8465	KIT RG+ 100 KBS PERFIL 118"	1	C+H
8466	KIT RG+ 100 KBS PERFIL 157"	1	C+H
8401	JGO. ACC. RG+ 100 KSC	1	G
8451	JGO. ACC. RG+ 100 KBS	1	H

ROLLGLASS+ 100 NEGRO			
Ref.	Descripción	U.	Img.
8457	KIT RG+ 100 KSC PERFIL 118"	1	D+I
8458	KIT RG+ 100 KSC PERFIL 157"	1	D+I
8467	KIT RG+ 100 KBS PERFIL 118"	1	D+J
8468	KIT RG+ 100 KBS PERFIL 157"	1	D+J
8402	JGO. ACC. RG+ 100 KSC	1	I
8452	JGO. ACC. RG+ 100 KBS	1	J

ROLLGLASS+ 150 SILVER			
Ref.	Descripción	U.	Img.
2549	KIT ROLLGLASS+ 150 SILVER V12 (118")	1	K
2548	KIT ROLLGLASS+ 150 SILVER V12 (157")	1	K
2541	KIT ROLLGLASS+ 150 SILVER V10 (118")	1	K
2542	KIT ROLLGLASS+ 150 SILVER V10 (157")	1	K

ROLLGLASS+ 150 NEGRO			
Ref.	Descripción	U.	Img.
2565	KIT ROLLGLASS+ 150 NEGRO V12 (118")	1	L
2568	KIT ROLLGLASS+ 150 NEGRO V12 (157")	1	L
2560	KIT ROLLGLASS+ 150 NEGRO V10 (118")	1	L
2561	KIT ROLLGLASS+ 150 NEGRO V10 (157")	1	L

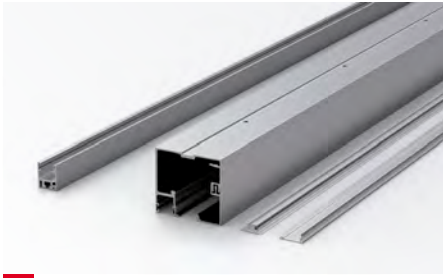

A

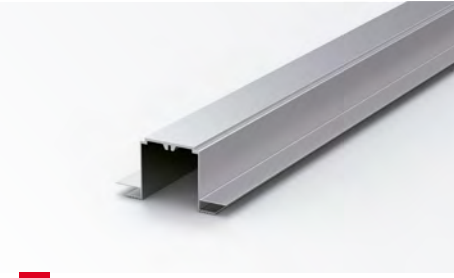

B

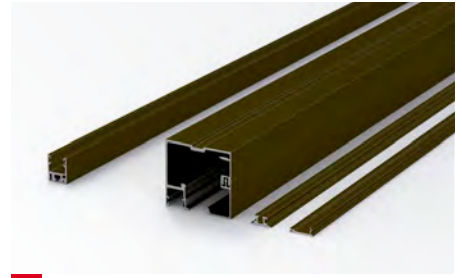

C

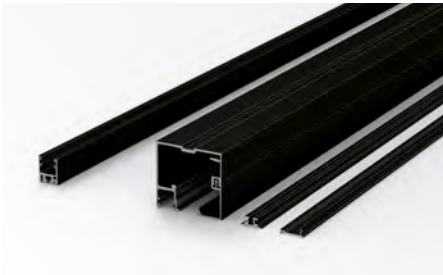

D



E

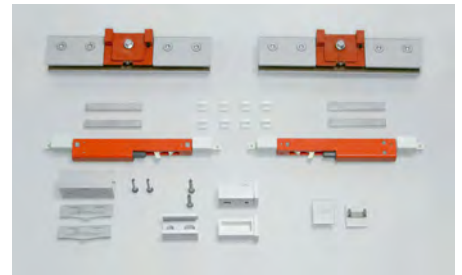

F



G



H



I

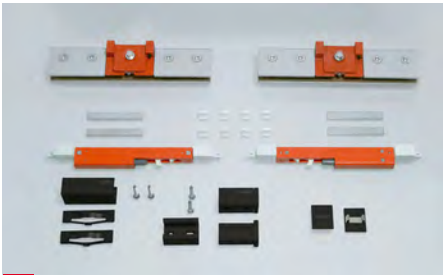

J



K



L

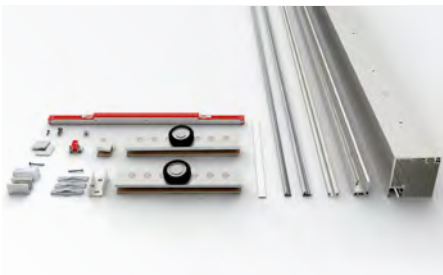

M



N

REFERENCES / REFERENCIAS

ENG

ROLLGLASS+ 150 TOP SILVER			
Ref.	Description	Units	Img.
2653	KIT ROLLGLASS+ 150 TOP SILVER V12 (118")	1	M
2654	KIT ROLLGLASS+ 150 TOP SILVER V12 (157")	1	M

ROLLGLASS+ 150 TOP BLACK			
Ref.	Description	Units	Img.
2697	KIT ROLLGLASS+ 150 TOP BLACK V12 (118")	1	N
2694	KIT ROLLGLASS+ 150 TOP BLACK V12 (157")	1	N

ROLLGLASS+ 250 SILVER			
Ref.	Description	Units	Img.
2524	KIT ROLLGLASS+ 250 SILVER 157"	1	O + R
2526	KIT ROLLGLASS+ 250 SILVER 236"	1	O + R

ROLLGLASS+ 250 BLACK			
Ref.	Description	Units	Img.
2564	KIT ROLLGLASS+ 250 BLACK 157"	1	Q + T
2566	KIT ROLLGLASS+ 250 BLACK 236"	1	Q + T

ESP

ROLLGLASS+ 150 TOP SILVER			
Ref.	Descripción	U.	Img.
2653	KIT ROLLGLASS+ 150 TOP SILVER V12 (118")	1	M
2654	KIT ROLLGLASS+ 150 TOP SILVER V12 (157")	1	M

ROLLGLASS+ 150 TOP NEGRO			
Ref.	Descripción	U.	Img.
2697	KIT ROLLGLASS+ 150 TOP NEGRO V12 (118")	1	N
2694	KIT ROLLGLASS+ 150 TOP NEGRO V12 (157")	1	N

ROLLGLASS+ 250 SILVER			
Ref.	Descripción	U.	Img.
2524	KIT ROLLGLASS+ 250 SILVER 157"	1	O + R
2526	KIT ROLLGLASS+ 250 SILVER 236"	1	O + R

ROLLGLASS+ 250 NEGRO			
Ref.	Descripción	U.	Img.
2564	KIT ROLLGLASS+ 250 NEGRO 157"	1	Q + T
2566	KIT ROLLGLASS+ 250 NEGRO 236"	1	Q + T

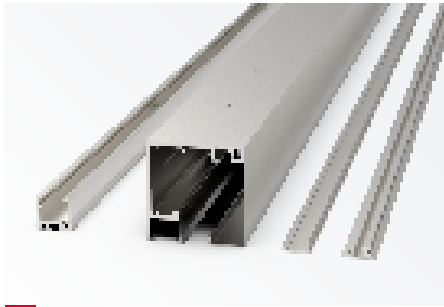

O

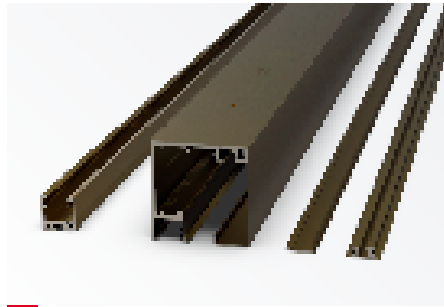

P

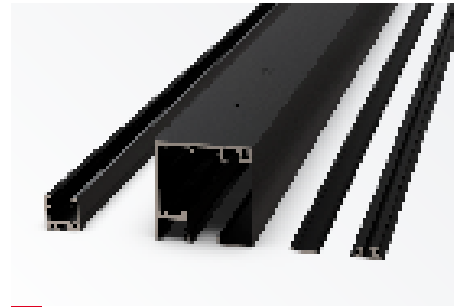

Q

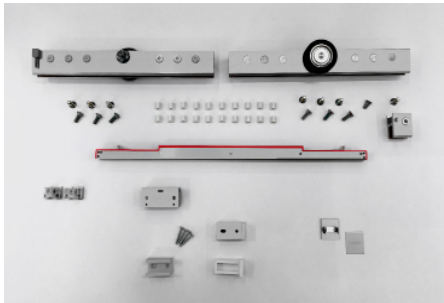

R

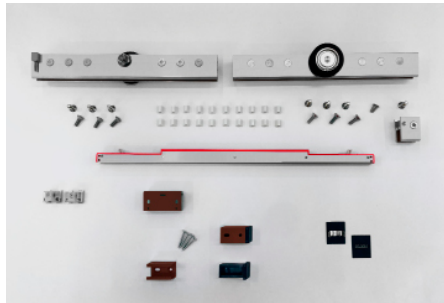

S

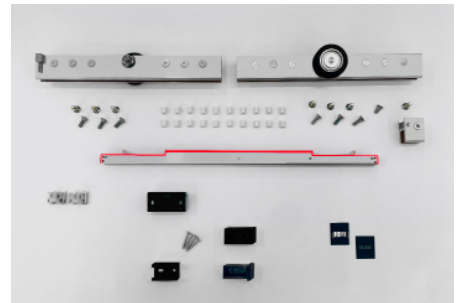

T

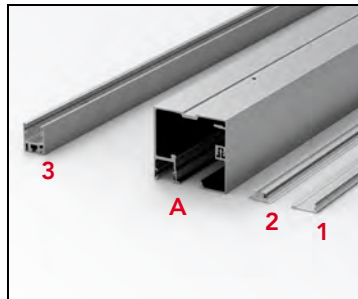

PROFILE'S DIMENSION / MEDIDAS DE LA PERFILERIA	
A	Longitud del perfil superior / Longitud del perfil superior
1	(100/ 150) A - 0,5 mts / (250) A - 2 m
2	A / 2
3	(100/ 150) A - 0,5 mts / (250 KIT 157") A - 1 m / (250 KIT 236") A - 1,5 m

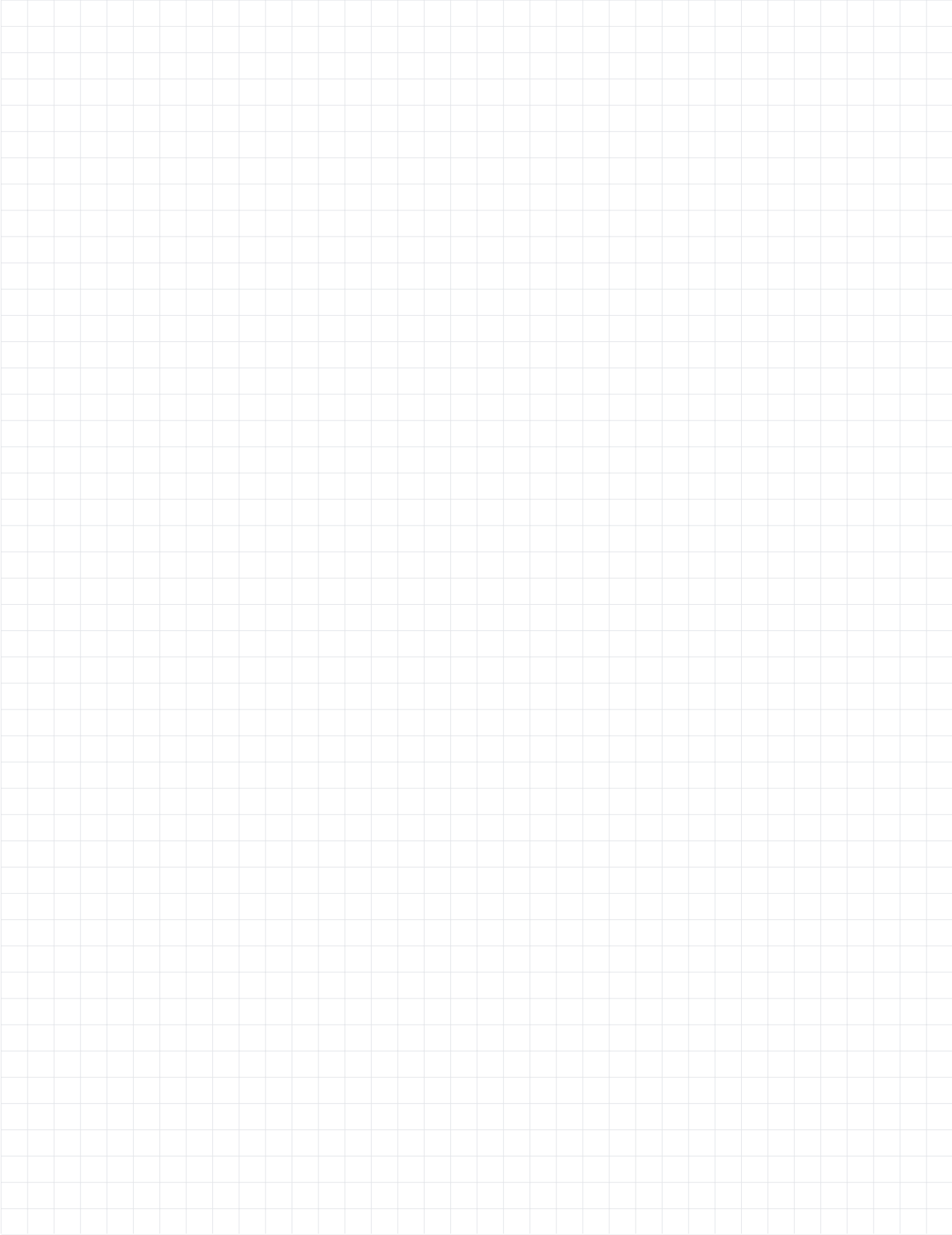

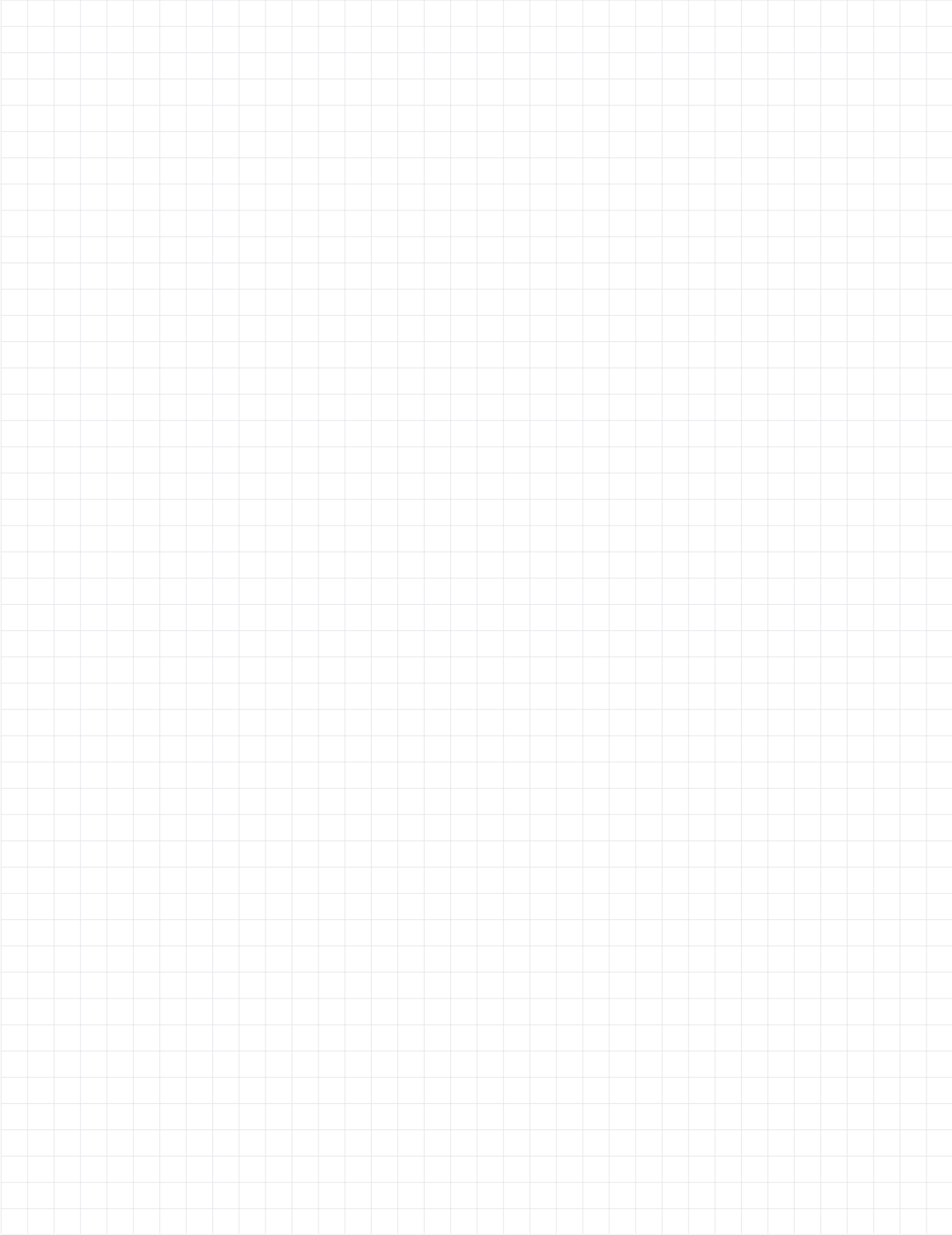

KLEIN

KLEIN USA, Inc.®
1 Madison Street
East Rutherford, NJ 07073

Phone: 973 246 8181
Fax: 973 246 8362
info@klein-usa.com
www.klein-usa.com

Follow us on social media
Síguenos en redes

